

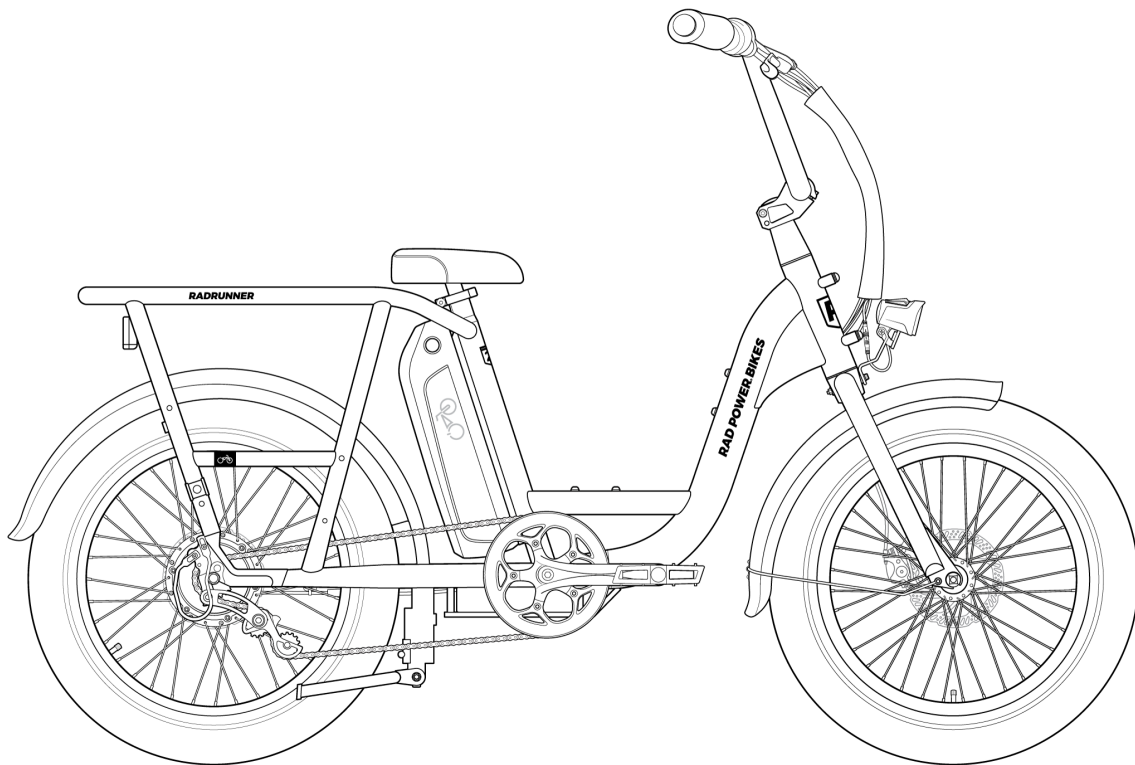



RadRunner[®] 2

OWNER'S MANUAL



Everyone at Rad Power Bikes cares about your safety and the safety of those around you. We want you to thoroughly enjoy your amazing ebike safely and reliably for many years to come.

 **WARNING:** DO NOT alter or modify anything in your ebike's electrical system, battery, digital controls, physical components, or drive train. Doing so may void your warranty. Any such modifications may result in damage to your ebike, other property, or injury or death to you or others.

 **WARNING:** This ebike is not to be operated by anyone under the age of 16. Children under the age of 16 may lack the necessary judgment and skill to safely operate the ebike, potentially resulting in damage to the ebike, damage to other property, serious injury, and/or death. Please also check your local laws, which may require a higher age. It is your responsibility to know and obey local regulations regarding rider age and other qualifications.



MINIMUM
OPERATOR AGE

 **DANGER:** Riding any bike, ebike, or similar vehicle without a helmet puts you at **VERY HIGH RISK** of serious head injury or death. Always wear a properly fitted helmet that covers the forehead. Many locations require specific safety devices. It is your responsibility to familiarize yourself and comply with the laws, rules, and regulations where you ride.



WEAR A HELMET

 **WARNING:** Any bike, ebike, or similar vehicle is subject to wear and tear, and certain components and fasteners can stretch or loosen with the vibrations and stress of normal operation. **You must check your ebike before each ride** and according to the other checklists in this manual. Failure to do so could result in property damage, serious injury, or death.



PRE-RIDE CHECK
rad-go.com/safety

Please read, understand, and follow all safety notices, cautions, and warnings in this manual and for any accessories or attachments you add to make your ebike perfect for you. **Stay safe! Ride Rad!**

Welcome to the Radventure!

Thank you for purchasing the RadRunner[®] 2 from Rad Power Bikes™!

We take pride in bringing you a quality product that will offer years of enjoyment. Please read and understand this manual fully before assembling and riding your ebike. The latest version of your manual, your assembly video, and other helpful content is available at the QR code and URL at right.

Be sure to check all hardware for correct torque (see [“Tools and torque specifications” on page 11](#)) during assembly. Before each ride, follow the recommendations in the [“Safety checklists” on page 29](#). Finally, take care of your new RadRunner by following the guidelines in [“Recommended service intervals” on page 32](#). If you're not sure you have the skills, experience, and special tools required for assembly and maintenance, get help from a local, professional, and reputable bike mechanic.

WE ARE HERE TO HELP! If you have questions after reading this manual and watching the assembly video, please consult the Rad Power Bikes Help Centre at radpowerbikes.eu/help.

Thanks for riding Rad!

Contents

Welcome to the Radventure!	1
Using this manual	3
Assembly instructions for the RadRunner	4
Tools and torque specifications	11
Adjusting for comfort and safety	12
Seat height	12
Handlebar angle	13
Brake lever angle	13
Fine-tune brake lever feel	13
Ensure all hardware is tightened properly	14
Battery information	15
Battery features	15
Safe operating temperatures	15
Removing and installing the battery	16
Before you charge	16
Charging procedure	17
Estimated charging times	18
Estimated range per full charge	18
Best practices for extending range and battery life	19
Battery storage	19
Summary: Battery recommended temperatures	19
Additional critical battery safety information	20
Operation	21
How the electrical system works	21
Battery key positions	21
Handlebar features	22
Electrical controls and operation	22
Headlight operation	22
Brake light	23
Start-up procedure	23
Parking, storage, and transport	24
Carrying cargo or a passenger	26
Weight limits	26
Carrying loads (cargo or passengers) safely	26
Carrying passengers	27
Carrying pets	28
Safety checklists	29

Maintenance	32
Check and service your ebike regularly	32
Recommended service intervals	32
Checking brakes & motor cutoff switches	33
Tyre and wheel care	34
Handlebar twist and push tests	35
Guard against rust, corrosion, and water damage	36
Troubleshooting	37
Fuse replacement	38
Error detection	39
Ride as safely as possible	40
Age and ability requirements	40
Know and obey all relevant local laws	40
Ride appropriately for conditions	40
Wear a helmet and appropriate safety gear	42
Limited warranty and other terms	43

Using this manual

This manual contains critical details about how to safely operate and maintain your RadRunner. Read it carefully and familiarize yourself with your ebike before riding it. Pay special attention to the safety messages shown here.

 **NOTICE:** A “notice” is important information that can help you avoid ebike/property damage or extend the life of parts and the ebike.



CAUTION: A “caution” indicates a hazardous situation that, if not avoided, could result in minor or moderate injury or property damage.



WARNING: A “warning” indicates a hazardous situation that, if not avoided, could result in death, serious injury, or property damage.



DANGER: A “danger” statement indicates a hazard that, if not avoided, has a very high risk of death, serious injury, or property damage.

Operating any bike, trike, or other vehicle always involves some risk of serious injury or death. Your safety depends on many factors including your skill, your ebike’s maintenance, and riding conditions. There are also factors you cannot control or anticipate. This manual makes no representations about the safe use of this product under all possible conditions. If you have any questions you should contact Rad Power Bikes immediately.

Assembly and first adjustment of your ebike from Rad Power Bikes requires special tools and skills. We recommend that you have this done by a professional, reputable bike mechanic. Keep this manual and any other documents that came with your RadRunner. All content in this manual is subject to change or withdrawal without notice. Visit radpowerbikes.eu/manual to view and download the latest version. Rad Power Bikes makes every effort to ensure the accuracy of its documentation and assumes no responsibility or liability if any errors or inaccuracies appear within.

Assembly instructions for the RadRunner

The following steps provide an overview of how to assemble your RadRunner 2 from Rad Power Bikes. They are not a complete or comprehensive manual of all aspects of assembly, maintenance, and repair, which involve specialized tools and skills. We recommend you consult a certified, reputable bike mechanic to assist in the assembly, repair, and maintenance of your RadRunner.

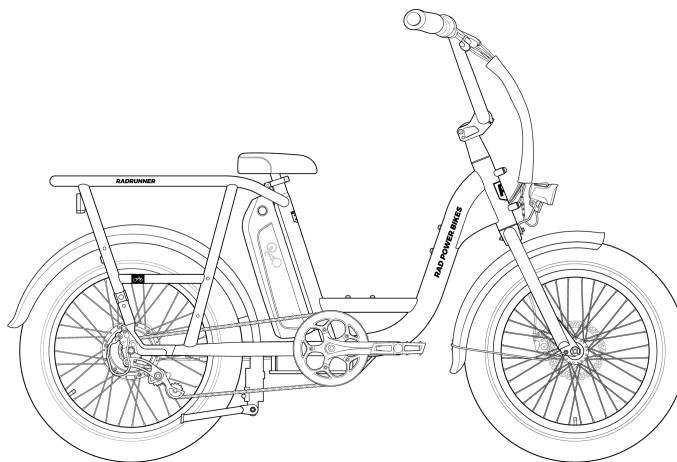

Fully
assembled
RadRunner

Please note that your ebike may include components that look different from those in this manual's illustrations. Such changes help ensure uninterrupted production and shipping. Our engineers rigorously test each component to guarantee quality and compatibility.



WARNING: Incorrect assembly, maintenance, or use of your ebike can cause component or performance failure, loss of control, serious injury, or death. Even if you're an experienced bike rider, **you must read and understand the entire manual and any documentation provided for subcomponents or accessories before riding.** If you are not sure you have the experience, skills, and/or tools to correctly perform all assembly steps in the manual and the assembly video at radpowerbikes.eu/manual, have a local, professional, reputable bike mechanic assemble your ebike.

1. **Unpack the ebike.** Open the bike box and, with the help of another person capable of safely lifting a heavy object, remove the ebike and place it upright on the back wheel and front fork protector plate. Carefully remove the packaging material protecting the bike frame and components. Keep the packaging materials in case you want to ship the bike later. Otherwise, recycle these materials, especially cardboard and foam, wherever possible. Remove the small box and carefully set out the contents. **Ensure all of the following items are included with the ebike:**

- Front wheel
- Front wheel quick release (in fork protector plate)
- Headlight
- Assembly toolkit
- Charger
- Pedals (left and right)
- Keys
- Manual(s)
- Stem faceplate and mounting hardware
- Rear fender (installed)
- Front fender and mounting hardware

If anything is missing, please contact Rad Power Bikes.

We also recommend the following (not included) for assembly and maintenance:

- Flat-side cutters
- 15 mm pedal wrench
- Bicycle grease
- Clean shop towel or paper towel for cleaning excess grease
- Bike pump with Schrader valve and pressure gauge
- Torque wrench (3-60 Nm) with Allen bits
- A strong friend

2. **Install the handlebar** following the steps below. For more information, view the assembly video available at radpowerbikes.eu/assemble.

- Locate the handlebar stem faceplate and hardware.** Set the bolts and faceplate aside near the handlebar.
- Orient the handlebar properly.** The brake levers should face forwards and the twist power assist should be on the right side. Trace the brake housing from the left brake lever to the brake calliper and make sure the bundle of cables is not twisted.

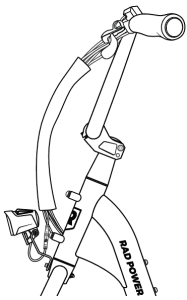

- Centre the handlebar on the stem.** Place the handlebar into position on the stem so it's centred and so that the handlebar is approximately parallel with the front fork when viewed from the side (see illustration).

Handlebar and cable positions

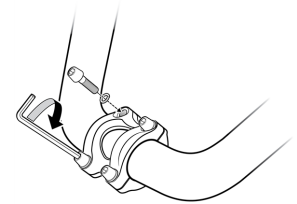
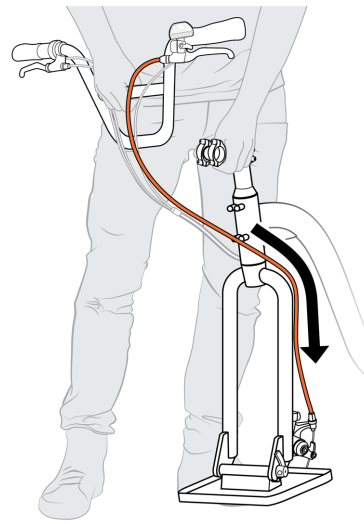

Stem faceplate bolts

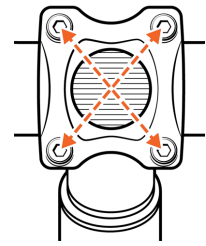

Tighten bolts in an "X" pattern

- Install the stem faceplate.** Place the stem faceplate over the handlebar, and thread in the four bolts by hand. Then use an Allen wrench to tighten the bolts evenly, by moving in an "X" pattern. Ensure the gap between the faceplate and stem is even.

- Torque the bolts evenly** to the value listed in ["Tools and torque specifications" on page 11](#). If, in the future, you decide to adjust the angle of the handlebar (e.g., to bring it slightly closer to the seat), be sure to follow the same procedures listed here to ensure the handlebar is properly secured.

3. **Install the front wheel onto the front fork** as explained below.



WARNING: Do not touch the brake rotor, which has sharp edges and can cause serious injury. Touching the brake rotor or brake pads with bare skin can also transfer natural oils. Oils or other lubricants can decrease braking performance. We recommend wearing protective gloves when working near the braking system.



- Locate and remove the quick-release skewer from the front fork protector plate.** Open the lever, remove the thumbnut and cone spring on the opposite side, and remove the skewer. Keep the cam follower (see "E" in the illustration that follows) and the other cone spring in place on the lever side.

QUICK-RELEASE SKEWER

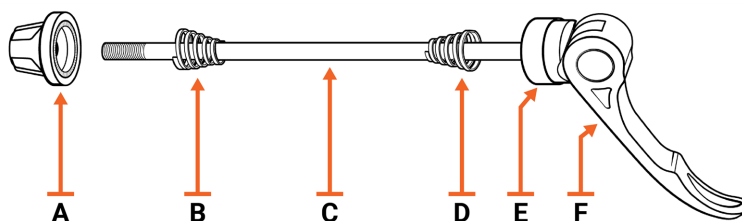

- A** Thumbnut (remove, set aside)
- B** Cone spring (remove, set aside)
- C** Quick-release skewer
- D** Cone spring
- E** Cam follower
- F** Quick-release lever

NOTICE: The "Quick-release skewer" illustration shows you the components you need to *retain*. You can discard the packaging that protected your front fork while shipping. That packaging includes a

plastic fork protector plate and a protective, hollow, metal rod that the skewer went through. Temporary, protective spacers may be on that hollow rod and their materials can vary, e.g., may be black plastic or look like thick metal washers. Do not put those spacers onto the quick-release skewer.

- b. **Install the skewer through the front wheel hub, starting from the side of the wheel *without* the brake rotor.** Make sure to not touch the brake rotor. Reinstall the cone spring on the skewer. Ensure both cone springs point inward. Keep the lever open and thread on the thumbnut a couple of turns, leaving enough room for the fork dropouts.
- c. **If there is a spacer between the brake pads, remove it now.**
- d. **Have a friend hold the bike steady and fully upright until you have finished securing the quick-release lever.** Do not prop the ebike on its kickstand.
- e. **Lift the front of the bike,** removing it from the protective plate.

NOTICE: The front-fork packaging includes the fork protector plate as well as a metal spacer rod and, in some cases, smaller spacers that go around that rod. The smaller spacers may be black plastic, metal, or other materials, and may look like thick washers. You can recycle these packaging elements according to local rules. Just be sure to retain all of the components pictured in [“Quick-release skewer” on the previous page.](#)

- f. **Carefully lower the front fork onto the wheel.** Pay attention to the brake rotor: It needs to slide between the brake pads. Once the rotor is between the brake pads, guide the fork onto the wheel so that the wheel axle enters the fork dropouts. (The fork dropouts are the slots on each end of the fork that the wheel axle fits into.)

NOTICE: If it's difficult to get the brake rotor between the brake pads, you may need to loosen the brake calipers slightly. Use an Allen wrench to widen the gap between the brake pads by turning the inner pad adjuster “out” (anticlockwise) two clicks. Stop after you feel two clicks or have turned the adjustment bolt one quarter to one half of a full rotation. When wheel installation is complete, you can turn the pad adjuster back “in” (clockwise) if necessary to ensure the brakes engage properly.



WARNING: Loosening the calipers too much (more than two clicks or more than half a full rotation) can cause very small brake components, including a tiny spring and ball bearing, to fall out of the brake assembly, and those will need to be reinstalled by a professional mechanic. Failure to have them reinstalled properly may compromise brake function, potentially leading to serious injury or death..

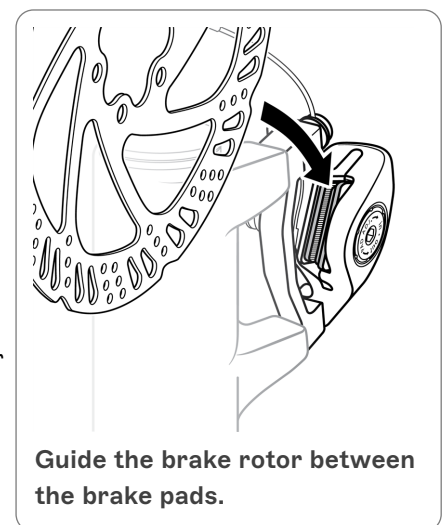

- g. **Double-check that the wheel is fully inserted into the dropouts,** that the wheel axle is level and parallel to the ground, and that the wheel is centred in the fork.

- h. **Make sure the quick-release lever is nestled into the curve of the cam follower**, as in the top image in the “Cam follower position” illustrations.
- i. **Make sure your friend is still holding the bike fully upright and steady**, which will ensure there’s even pressure on both sides of the axle. This is critical for the next step.
- j. **Secure the quick-release lever.**

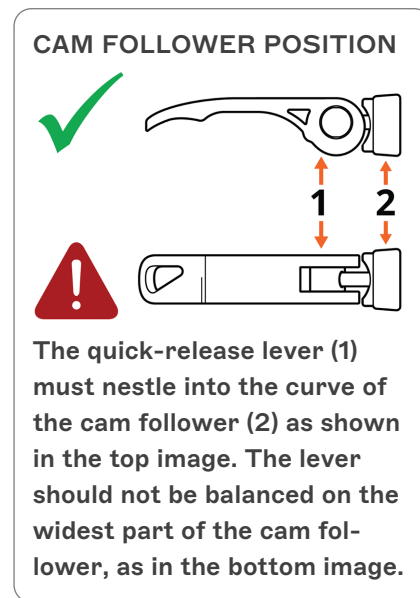
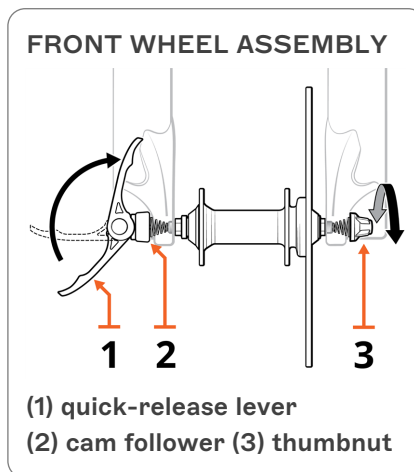

NOTICE: The security and stability of your front wheel depends on very tight clamping force from the quick release lever. A properly adjusted quick-release lever requires great force to close or open.

- i. Open the quick-release lever all the way. Hold the thumbnut steady with one hand while you spin the quick-release lever clockwise with the other hand. Tighten the lever as much as you can by hand.
- ii. At this point, the lever should be too tight for you to close it halfway. Loosen it by a quarter spin and try to close the lever halfway again. Repeat until you can close the lever halfway.
- iii. Make sure the lever is angled so that when you close it, it won’t hit any bike components like the fork or a fender bracket, which could keep it from closing fully.
- iv. Close the lever. This *should* be difficult and should leave an imprint in your hand. **Fine-tuning the tightness of the lever can take several tries.**

WARNING: If you cannot exert great force on the quick release lever to close it, you must seek help from a professional bike mechanic. Failure to fully secure your front wheel can lead to serious injury or death.

- k. **Inspect your front wheel installation:**
 - Make sure the closed quick-release lever doesn’t touch any bike components such as the fork, which could keep it from closing fully.
 - Check that the same amount of dropout is visible under the axle on each side of the bike. (If there’s a difference, your axle is not fully inserted into both dropouts, and you’ll need to repeat the previous steps starting at the point where you check that both cone springs are pointing inward.)
- l. **Test your front wheel installation** using these three tests:
 - With your friend holding the front wheel off the ground, spin the front wheel to ensure it has no wobble or looseness.
 - While straddling the bike with hands on the handlebars, squeeze the front-brake lever with your left hand. Rock the bike forwards and backwards. Ensure the front brake prevents the front wheel from spinning and that there’s no play or wiggle in the wheel, handlebar, or front fork.
 - Inspect the quick-release lever to ensure it has remained tightly closed.
- m. **Check the security of the rear wheel.** You must also check the torque value of the rear wheel axle nut to ensure it’s correctly tightened (see [“Tools and torque specifications” on page 11](#)).

NOTICE: Inspect and test both wheels before each ride. Either wheel and other components can loosen over time and with the normal vibration of riding.

WARNING: An improperly secured front or rear wheel can cause loss of control, accidents, serious injury, or death. Check that the wheels are properly secured during assembly and before each ride.

4. **Perform a handlebar twist and push test** to ensure the front wheel and handlebar stem are securely connected. Instructions for doing so are in [“Handlebar twist and push tests” on page 35.](#)
5. **Install the front fender/mudguard and headlight.**
 - a. **Locate the fender/mudguard and mounting hardware.**
 - b. **Remove the headlight mounting hardware** from the top of the fork.
 - c. **Pass the fender/mudguard from the back of the front wheel**, under the fork, as shown below.

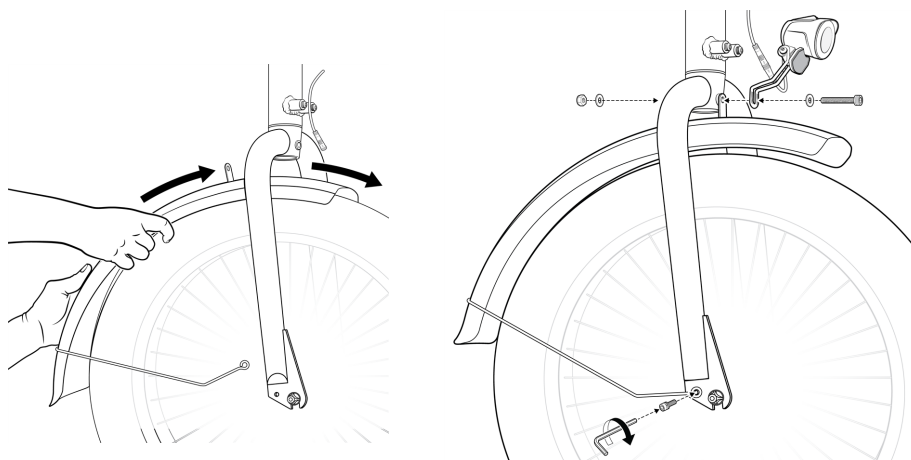

Pass the fender from the back of the front wheel

Headlight/fender mounting hardware

- d. **Install the fender/headlight mounting hardware** through the headlight bracket, fender, and fork as shown above. Pass a washer over the bolt end, pass the bolt end through the headlight mounting bracket and the fender mounting point, and then pass the bolt through the mounting point on the fork. On the other side of the fork, pass another washer over the bolt, and then thread the locknut on by hand. Torque the locknut according to the value listed in [“Tools and torque specifications” on page 11.](#)
 - e. **Locate the fender/mudguard mounting hardware.** Pass a split washer and a flat washer over each bolt end.
 - f. **Secure the fender mounting arms.** Pass a fender arm eyelet over the mounting point on the bike and thread in the bolt by hand. Repeat with the other fender arm.
 - g. **Check that the fender/mudguard and headlight are centred**, then torque the fender/mudguard mounting arm bolts according to the value in [“Tools and torque specifications” on page 11.](#)
6. **Plug in the headlight connector.** Line up the internal notch and pins with the external arrows, and press directly together without twisting.
7. **Adjust the headlight angle slightly downwards** so it won't blind oncoming traffic. Using the tools listed in [“Tools and torque specifications” on page 11,](#) loosen the angle adjustment bolt and locknut, angle the headlight downwards, and tighten securely. Do not overtighten.

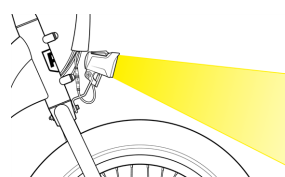
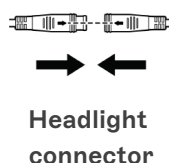

Headlight pointing slightly downwards to not blind others

8. Install the pedals.

- a. **Locate the right-side pedal**, which is marked “R,” should have an “R” sticker attached, and has a smooth pedal axle. The right pedal goes on the crank on the drivetrain side of the bike, which has the chain and is the same as a rider’s right side when seated on the bike.
- b. **Place a pea-size or slightly smaller amount of bicycle grease onto the threads of the right pedal.**
- c. **Carefully thread the right pedal onto the right crank by turning clockwise** (towards the front of the bike). Do so slowly and gently by hand. Do not cross thread or damage the threads. See the [“Right pedal installation”](#) illustrations.
- d. **Place a pea-size or slightly smaller amount of bicycle grease onto the threads of the left pedal.**
- e. **Carefully thread the left pedal onto the left crank by turning anticlockwise** (towards the front of the bike). The reverse-threaded left pedal is marked with an “L,” should have an “L” sticker attached, and has notches on the pedal axle. Thread slowly and gently by hand without cross-threading or damaging the threads. See the [“Left pedal installation”](#) illustrations.
- f. **Tighten each pedal using a pedal wrench.** You can also use a torque wrench with a crowfoot bit for this task, but regular wrenches won’t fit in the narrow space and may damage your pedal or crank.
- g. **Torque each pedal to 35 Nm.** An experience mechanic can torque properly with a pedal wrench, but if you're less experienced, use a torque wrench with a crowfoot bit.
- h. **Wipe off any excess bicycle grease.**

RIGHT PEDAL INSTALLATION

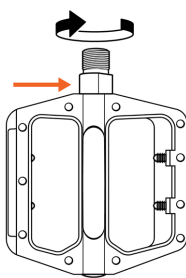

Right pedal with smooth pedal axle.

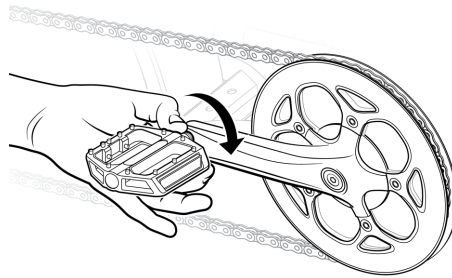

Thread the right pedal onto the right crank gently by hand, turning clockwise.

LEFT PEDAL INSTALLATION

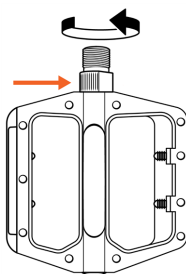

Left pedal with notches on the pedal axle.

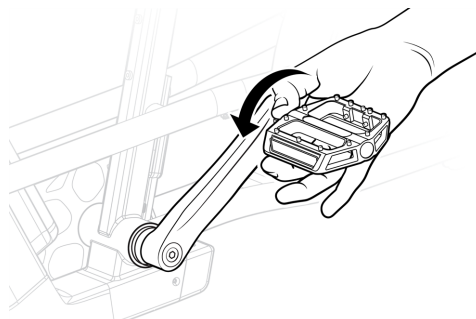

Thread the left pedal onto the left crank gently by hand, turning anticlockwise.

PEDAL WRENCH USE

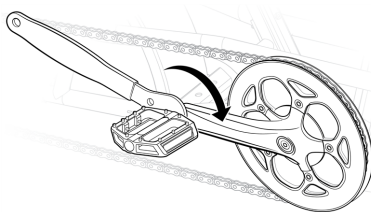

Right pedal: clockwise

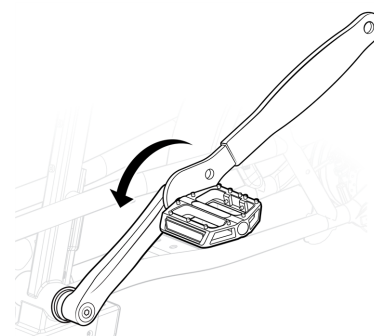

Left pedal: anticlockwise



WARNING: Improperly or inadequately tightened pedals can fall off your bike while you’re riding, leading to component damage, serious injury, or death. If you aren’t sure how to tighten your pedals or don’t have appropriate tools, please get help from a professional mechanic.

9. **Inflate the tyres.** Check that the tyre beads and tyres are evenly seated (fully inserted into the rims). Use a pump with a Schrader valve and pressure gauge to inflate each tyre to the recommended PSI (pounds per square inch) indicated on the tyre sidewall. Do not overinflate or underinflate tyres. For more information, see [“Tyre and wheel care” on page 34](#).
10. **Check the chain alignment.** Stand at the right side of the bike and grab the right pedal. Rotate the right pedal and crank towards the back of the bike as though pedalling backwards—this will run the chain through the drivetrain without spinning the wheels. Watch the chain and ensure the chain runs through the drivetrain (the rear cog, chain tensioner, and around the front chainring) smoothly. If the chain doesn't run smoothly or something seems misaligned, please consult our online Help Centre (radpowerbikes.eu/help).
11. **Check the bashguard position.** The bashguard that helps protect your chain tensioner from impact damage must be positioned so that it does not touch or interfere with the operation of the chain tensioner. If the bashguard is too close to the bike, do the following:
 - a. Ensure that the axle nuts are torqued to the value listed in [“Tools and torque specifications” on the next page](#).
 - b. Gently pull the bashguard away from the bike, by hand, so that the chain tensioner can operate correctly.
12. **Finish the assembly.** Complete all steps in [“Adjusting for comfort and safety” on page 12](#), including checking that all hardware has been tightened according to the values in [“Tools and torque specifications” on the next page](#). Before your first ride, be sure to perform the safety checks in [“Maintenance” on page 32](#) including the handlebar twist test in [“Handlebar twist and push tests” on page 35](#).

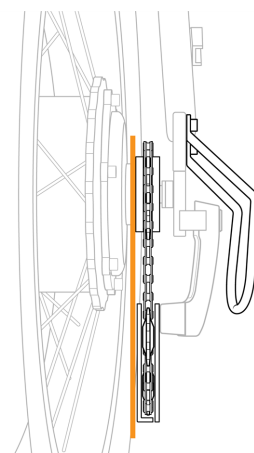

Correct chain and bashguard position



The bead is the hard, rounded end of the tyre that goes into the wheel rim.

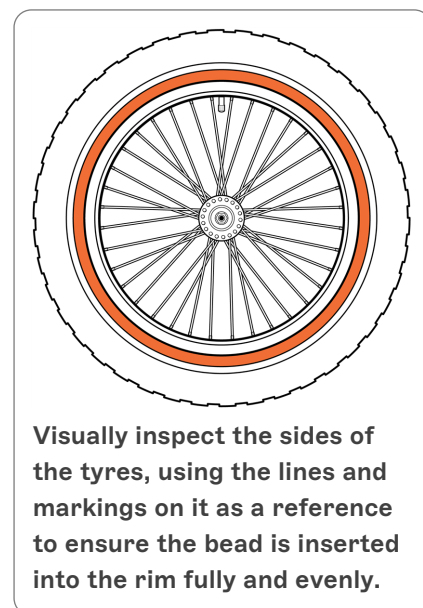

Visually inspect the sides of the tyres, using the lines and markings on it as a reference to ensure the bead is inserted into the rim fully and evenly.

Tools and torque specifications

The tool sizing listed below is a general guide, but it is possible that the head of a particular bolt on your ebike may vary, requiring a different tool (e.g., a 4 mm Allen wrench instead of a 5 mm Allen wrench). If so, use whatever tool fits the bolt head. Such differences will not affect the recommended torque for that piece of hardware.

If you are installing accessories from Rad Power Bikes, any necessary instructions, important safety information, and torque specifications will come with your accessory and/or be available online at radpowerbikes.eu/help.

		Tool	Rec. torque
Handlebar area	Stem faceplate bolts	5 mm Allen	8 Nm
	Stem clamp bolts	5 mm Allen	15 Nm
	Headlight angle adjustment bolt	4 mm Allen, 8 mm wrench	tighten securely; do not overtighten
	LED display clamp bolt	3 mm Allen	3 Nm
	Brake lever clamp bolts	5 mm Allen	6 Nm
	Twist power assist clamp bolt	3 mm Allen	3 Nm
	Brake area	Calliper adapter to frame	5 mm Allen
Calliper to adapter		5 mm Allen	6-8 Nm
Cable pinch bolt on calliper arm		5 mm Allen	6-8 Nm
Brake rotor to hub		T-25 Torx bit	7 Nm
Brake pads to calliper		Needle-nose pliers	90° bend at tip of cotter pin
Seat area	Seat mounting bolts	13 mm Allen	10 Nm
	Battery tray mounting bolts to frame	4 mm Allen	6 Nm
Rear dropout area	Rear axle nut	18 mm wrench	40 Nm
	Torque arm bolt	4 mm Allen	5 Nm
	Chain tensioner hanger mounting bolt	5 mm Allen	6 Nm
	Chain tensioner mounting bolt	5 mm Allen	6 Nm
	Kickstand mounting bolts	8 mm Allen	30 Nm
Bottom bracket and crank area	Pedal into crank arm	15 mm pedal wrench	35 Nm
	Crank arm removal info	Crank puller for square tapered bottom bracket spindle	n/a
	Crank arm bolt into bottom bracket spindle	8 mm Allen	35 Nm
	Chainring bolts	6 mm Allen	10 Nm
	Controller mounting bolts: controller to skid plate	3 mm Allen	3 Nm
	Controller mounting bolts: skid plate to frame	4 mm Allen	6 Nm
	Bottom bracket and cups	BBT-22 Park Tool	60 Nm

Adjusting for comfort and safety

The following steps are critical for your comfort and safety, and **must** be performed before your first bike ride. We recommend that you consult a bike fitting professional such as a certified, reputable bike mechanic who specializes in bike fit.

Seat height

An ideal seat height will allow you to be comfortable and get the best pedalling efficiency. When you are seated, you should be able to place the ball of your foot on the pedal at its lowest position while your leg is almost fully extended, with your knee slightly bent. The seat should never be so high that you need to rock side to side or fully straighten your legs while pedalling. Never pull out the seatpost so far that the minimum insertion point is visible above the seat tube (see illustration).

Depending on your preference, ability, and amount of experience with bike and ebike riding, you may find that lowering the seat so you can put one or both feet on the ground without dismounting may offer a safer and more comfortable experience.

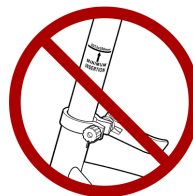

Seatpost out TOO FAR

The minimum insertion point on the seatpost must be inserted into the seat tube.

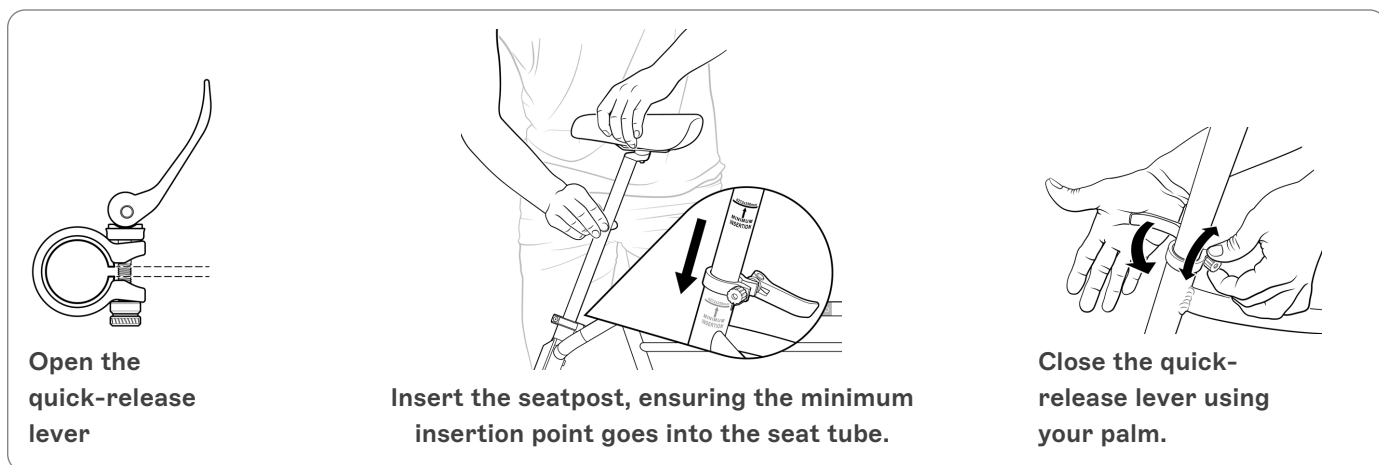

Open the quick-release lever

Insert the seatpost, ensuring the minimum insertion point goes into the seat tube.

Close the quick-release lever using your palm.

1. **Open the seatpost quick-release lever.**
2. **Slide the seatpost in or out of the seat tube** to a height appropriate for your leg length and preference. *Do not extend the seatpost beyond the minimum insertion marking etched onto the seatpost* (see the [“Seatpost out TOO FAR”](#) illustration).
3. **Align the quick release clamp opening with the notch in the seat tube, and close the quick-release lever fully.** Closing the lever should require enough pressure that it leaves an imprint in your hand. When closed, the seat should not move up, down, left, or right. If needed, adjust the lever tension by turning the adjustment nut opposite the quick-release lever.



WARNING: A loose seatpost can cause your seat to drop suddenly, which can lead to loss of control, component damage, serious injury, or death. Regularly check to make sure that your seat’s quick-release lever is properly tightened.

4. **Try out your seat fit**, and repeat steps 1–3 if the seat position needs a bit more adjusting.



DANGER: Overextending the seatpost can cause it to break or fall off your ebike, which will put you at very high risk of serious injury or death. Avoid this danger by inserting your seatpost into the seat tube far enough that the minimum insertion point is no longer visible.

Handlebar angle

Most riders will feel comfortable with the handlebar angled so that it is roughly parallel with the front fork, as shown in the more vertical position of the illustration. Once you have adjusted the seat to your leg length and preference, you may decide that you would like the handlebar to be angled slightly closer to the seat. If so, follow these steps.

1. **Loosen the four stem faceplate bolts** just enough to allow the handlebar to pivot, and position it as you prefer.
2. **Re-tighten the stem faceplate bolts** using the method described in the assembly instructions.
3. **Test the positioning by sitting on the bike**, making sure it's comfortable and that the handlebar can turn freely without touching your body.
4. **Inspect the stem faceplate bolts.** Be sure the gap between the faceplate and stem at each bolt is even and torque all faceplate bolts according to the value listed in [“Tools and torque specifications” on page 11.](#)
5. **Test the security of your handlebar by performing a handlebar twist and push test.** See [“Handlebar twist and push tests” on page 35.](#)

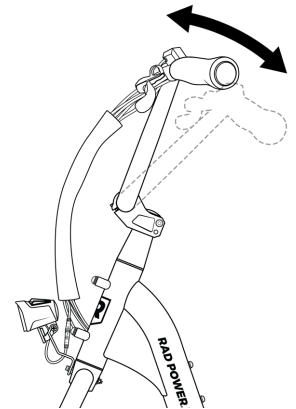

Brake lever angle

The angle of the brake levers can be adjusted for the most comfortable hand position possible. For most riders, this will allow them to rest two or three fingers comfortably on the brake lever while keeping their wrists in a neutral position. To adjust the angle, follow these steps:

1. **Loosen the brake lever clamp bolt** using the appropriate Allen wrench.
2. **Adjust the angle of the brake lever** so it's comfortable for the rider.
3. **Retighten the brake lever clamp bolt** according to the value listed in [“Tools and torque specifications” on page 11.](#)

TIP! Another way to maximize hand comfort is to angle your handlebar grips so that the wide section of the grip supports the outside part of your palm and keeps your wrists in a neutral position while you have two or three fingers resting on each brake lever. You should be able to reposition the handlebar grips by applying firm pressure and twisting. If they don't move, you can apply a small amount of rubbing alcohol between the grip and the handlebar as temporary lubrication:

1. **Carefully insert a screwdriver between the handlebar tubing and the grip.**
2. **Pry the grip away from the handlebar slightly.**
3. **Use a paper towel or squeeze bottle to apply alcohol into the gap.** This should help loosen the grip.
4. **Twist your grip into the best position for your comfort**, testing by trying the brake levers while seated.
5. **Give the alcohol an hour to evaporate**, and then test that your grips are secure before riding your ebike.

Fine-tune brake lever feel

The “feel” of the brake levers is how far the brake levers need to be squeezed for the brake pads to press against the brake rotor. Squeezing the levers halfway between the starting position and the handlebar grip should result in a firm lever feel and the brake pads are pressing firmly against the brake rotor.

If needed, you can make fine adjustments to the brake lever feel by tightening or loosening the brake cable tension by rotating the barrel adjusters at the brake lever housings and/or at the brake callipers. For more information on brake lever feel and brake cable tension, please see the resources in our Help Centre at radpowerbikes.eu/help.

If needed, you can make fine adjustments to the brake lever feel by adjusting a set screw in the brake lever. That screw is located



DANGER: Always make your brake levers can't touch the handlebar grip when you squeeze firmly. A brake lever that can touch the grips may not engage the brakes fully, causing you to have difficulty slowing or stopping and putting you at very high risk of serious injury or death. Squeezing the brake lever halfway towards the handlebar grip should cause the brake pads to press firmly against the brake rotor. If you think your brakes may not be functioning properly, do not ride your ebike. Check our online Help Centre for more information (radpowerbikes.eu/help).

Ensure all hardware is tightened properly

Ensure all hardware is tightened properly according to the values in "[Tools and torque specifications](#)" on page 11.

This is a critical safety step that you must not skip. If you do not own a torque wrench or you do not have the skills to check the tightness of your hardware, consult a local, professional, reputable bike mechanic for help. You can find more information about bike fit and making adjustments to your ebike in our Help Centre at radpowerbikes.eu/help.

Battery information

The battery that comes with your RadRunner is a state-of-the-art, lithium-ion battery that's designed to give you years of power with proper care and use. Follow the recommendations here for the best possible performance.

Battery features

Please familiarize yourself with all of the components of your battery. When you are seated on your ebike, the charging port of your battery will be on the right side of the battery.

CAUTION: Do not put any object into your battery's charging port other than the Rad Power Bikes charging plug designed for this purpose (and pictured in the illustration). Inserting other objects into the charging port could damage your battery.

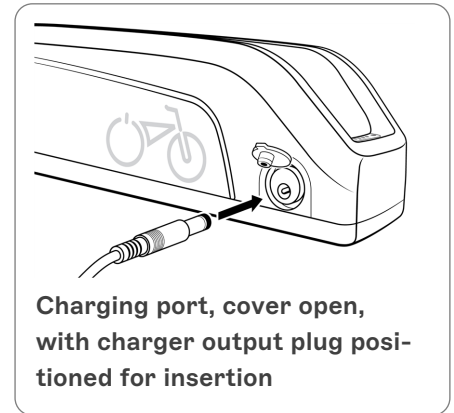
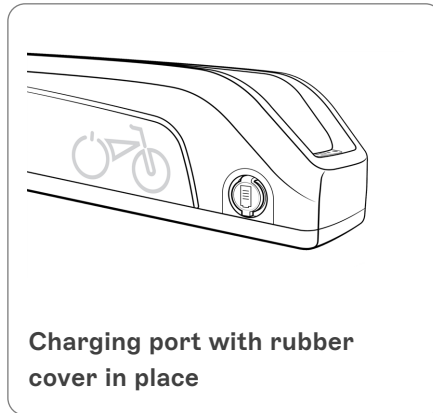

The other side of your battery includes the keyport. Use your key to lock or unlock your battery from the frame and to turn the battery on (make its power available to your ebike's electrical system). **Always remove your key from the battery before riding.**

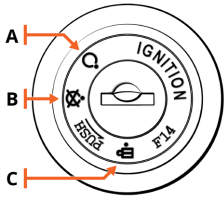

KEYPORT AND KEY POSITIONS	
	Description
A	Power on, battery locked to frame
B	Power off, battery locked to frame
C	Power off, battery unlocked from frame (for battery installation and removal)

CHARGE LEVEL

On the top of your battery there is a button and 5 charge indicator LED lights. The first is red, the others are green. When you press the button, the LEDs will give you an approximation of your charge level: zero lights indicate zero or nearly zero charge, one light indicates about a 20% charge, two lights indicate about a 40% charge, and so on. When the battery is nearly empty, the first LED will blink.

Safe operating temperatures

We recommend riding in temperatures between -15°C to 40°C (5°F to 105°F). Colder or hotter temperatures increase risks to your health and can also cause harmful internal battery temperatures.

Riding in very hot temperatures: Know and respect your physical limits around exercising in hot temperatures, and consult your doctor if you have any concerns. To prevent damage to your battery, do not ride in temperatures above 40°C (105°F). If you choose to ride in extremely hot temperatures, use low levels of power assistance (low pedal assist levels, low use of twist power assist) to keep the battery as cool as possible. This may lower the risk of the battery automatically turning off to prevent use-caused heat damage.

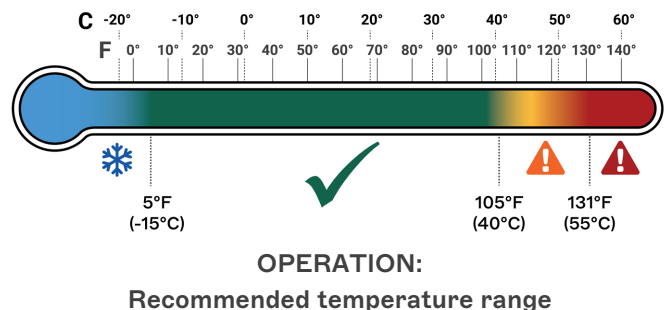



DANGER: Do not ride in extremely hot temperatures. The more the ambient temperature exceeds 40°C (105°F), the greater your risk of exceeding a maximum internal battery temperature of 55°C (131°F). This can cause the battery to turn off as a safety precaution. Extreme heat may also cause critical failure of the battery up to or including an electrical fire. Factors that increase your risk for battery overheating include, but are not limited to, ambient temperatures above 40°C (105°F), direct sunlight for extended periods, high twist power assist usage, high PAS level, high payload, steeper inclines, and other environmental factors.



WARNING: Extreme cold of -15°C (5°F) or below will reduce the range of your battery and can cause the battery to shut off automatically to prevent damage. Do not depend on battery power to return you back to safety if riding near those extreme temperatures. Riding in freezing temperatures can also expose your ebike to de-icing salt, which can harm your ebike and electrical components or cause an electrical fire. See [“Guard against rust, corrosion, and water damage” on page 36](#) for more information.

Removing and installing the battery

You can charge your battery either on or off your RadRunner. If you remove it for charging, storage, transportation, security, or some other reason, keep these procedures to prevent battery damage.

BATTERY REMOVAL

To remove the battery, turn its key to the off and unlocked position (see [“Battery features” on the previous page](#)) and remove the key from the keyport. Carefully pull the battery forwards and up until the battery detaches from the battery mount.

NOTICE: When the battery is off its mount, protect the battery terminal contacts from damage or exposure to harmful substances including liquids and salt. Do not touch the terminal contacts. If the terminals become damaged, please discontinue use and contact Rad Power Bikes Product Support immediately.

BATTERY INSTALLATION/MOUNTING

1. **Make sure the battery keyport is in the “power off/unlocked from frame” position.** (See [“Battery features” on the previous page](#).) Remove the key.
2. **Align the notches on the back of the battery between those in the battery mount.** Slowly slide the battery down until it's secure. Do not force the battery into the battery mount.
3. **Turn the key on the battery to the locked position.**
4. **Test the security of the battery by carefully pulling up on it with both hands.** The battery should not move during this test.

Before you charge

NOTICE: Failure to follow the battery-charging best practices outlined in this manual could result in unnecessary wear to the battery and/or charger, and could lead to an underperforming or non-functional battery. Batteries damaged due to improper care will not be replaced under warranty.

Where to charge. Always charge in a safe, dry, indoor area that is away from children, direct sunlight, dirt, debris, tripping hazards (including electrical cords), or any materials that could ignite in the unlikely event of a charger or battery malfunction. Arrange the bike, battery, and charger to eliminate the potential for falls or other impacts. Make sure you stay close enough to it to check on it occasionally.

Check the condition of your battery and charger. Make sure the battery, charger, and electrical cables show no signs of damage. The terminals on the battery and its mount should be free of dirt, rust, corrosion, and leakage.



WARNING: When charging any powerful battery, locate it somewhere you can get to it easily (or maneuver past it to safety) should there be a fire. Do not place it in a hallway or near a door such that it could block your exit in an emergency.



WARNING: Letting a battery charge unattended increases the risk that a charging problem will go undetected and lead to component damage or a fire hazard. Always charge your battery where you can monitor it.

Ensure the ambient temperature is appropriate. For best charging performance and to minimize wear and tear on components, we recommend charging at ambient temperatures of 5°C to 25°C (41°F to 77°F). Your battery generates heat while charging, but it's designed to air-cool, so keep it uncovered with the light facing upwards on a flat, stable, hard, unheated surface. At relatively low temperatures, charging can take longer.

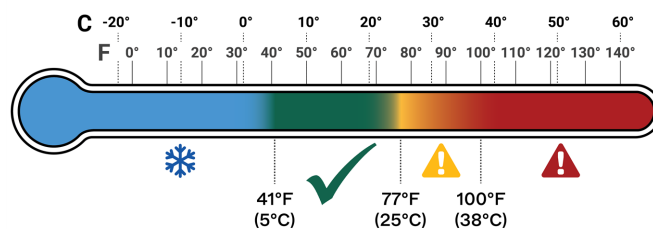

CHARGING:
Recommended temperature range

CAUTION: Do not charge your battery when it is warm from riding or in ambient temperatures above 38°C (100°F) to prevent unnecessary wear and tear on battery and charger. If the battery has turned off to prevent heat damage, wait until the battery cools down to turn the battery back on. Never charge your battery on or near heat-generating devices.

WARNING: Charging your battery with a charger other than one supplied by Rad Power Bikes and designed for your specific ebike model can cause damage to your ebike's electrical system or create a safety hazard. Only use a battery charger designed for your ebike and supplied by Rad Power Bikes.

WARNING: Using a damaged battery or charger can damage additional components or create a fire hazard. **Stop using your battery and charger and contact Rad Power Bikes immediately if any of the following occur:**

- Your charger's flexible power cord or output cable or any of the electrical cables on your ebike is frayed, has broken insulation, or any other signs of damage,
- Your battery or charger is physically damaged, non-functional, or performing abnormally,
- Your battery or charger experienced a significant impact from a fall, crash, or shipping damage, with or without obvious signs of damage,
- Your battery is leaking a clear, pungent, gel-like substance (which is potentially corrosive and flammable),
- Your battery will not fully charge (not all of the LEDs will light up) after the battery has been charging long enough so that it should be fully charged, i.e., it's been plugged in at least an hour longer than the time cited in "[Estimated charging times](#)" on the next page and/or the LED or LEDs on the charger indicate it has finished charging.
- Your battery was submerged in liquid or had extensive water exposure or damage, or
- Your charger becomes too hot to touch (it's designed to get warm with normal use), makes an unusual smell, makes a popping sound, or shows other signs of overheating.

Store any damaged or potentially damaged battery or charger in a safe, dry location away from the house and other flammable materials/structures and, as soon as possible, recycle or otherwise dispose of it according to local rules. Replacement batteries and chargers are available at radpowerbikes.eu.

Charging procedure

To charge your battery, mind the advice in "[Before you charge](#)" on the previous page and then follow these steps.

1. **Turn the power off.** Press and hold the power button on the UI Remote until the display turns off. If desired, use the key to unlock and remove the battery from the ebike frame. The battery can be charged either on or off the ebike.

- To charge the battery while it's **on** the RadRunner: align the key with position B in the "Keyport and Key Positions" illustration.

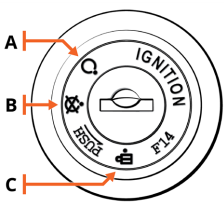

KEYPORT AND KEY POSITIONS	
	Description
A	Power on , battery locked to frame
B	Power off , battery locked to frame
C	Power off , battery unlocked from frame (for battery installation and removal)

- To charge the battery while it's **off** the RadRunner: align the key with position C in the illustration. Make sure to remove the key from the battery, and then remove the battery from the ebike.

2. **Locate the charging port of the battery.** The charging port is on the opposite side of the battery from the keyport. Note that the charging port includes a cover; the keyport does not have a cover.

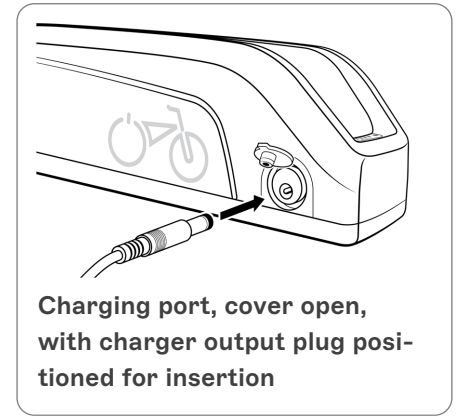
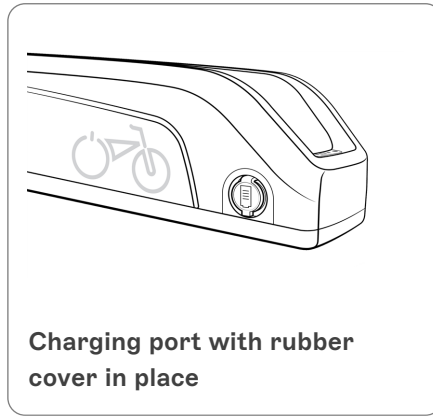

3. **Place the charger on a flat, secure surface if you have removed it from your ebike.** The charging indicator light should face up.

4. **Plug the charger into the battery charging port.** Open the flexible cover on the charging port. Connect the charger's round barrel connector to the charging port on the side of the battery.
5. **Plug the charger into a power (wall) outlet.** Charging should initiate and will be indicated by the LED on the charger turning green (to indicate power source connection) and then immediately turn red to indicate active charging. When charging is complete, the LED will turn green again.
6. **When charging is complete, unplug the charger from the power (wall) outlet, and then unplug it from the battery.** Be sure to pull gently on the plugs, not on the cables themselves.

NOTICE: The charger is designed to stop charging automatically when the battery is full. Store the charger carefully, making sure its plug does not come in contact with liquids, dirt, debris, or metal objects, which can damage the plug and interfere with future operation.

Estimated charging times

The time needed to fully charge your battery depends on its age, how far it was used to travel, the nature of that travel (terrain, payload, PAS and twist power assist use, etc.), and other factors. The table here provides a rough estimate of charge time based on distance travelled with moderate use of motor assistance. Charging at low temperatures can increase recharge time.

NOTICE: The battery may take longer to charge when fully depleted, when very new, and after 3–5 years of regular use. If your battery doesn't seem to be charging normally, is taking longer to charge than expected, or you're experiencing substantial reduction in range, discontinue use and contact Rad Power Bikes Product Support.

Distance	Recharge time
8 km (5 mi)	.75 hour
16 km (10 mi)	1.5 hours
24 km (15 mi)	2.25 hours
32 km (20 mi)	3 hours
40 km (25 mi)	3.75 hours
48 km (30 mi)	4.5 hours
56 km (35 mi)	5.25 hours
64 km (40 mi)	6 hours
72 km (45 mi)	7 hours

Estimated range per full charge

We suggest that you select a lower PAS level when you're getting to know your RadRunner and travel routes. Once you become familiar with your range requirements and the capabilities of your ebike, you can adjust your riding characteristics.

The table in this section provides range estimates to help you understand the factors that can increase or decrease range. Rad Power Bikes makes no claims about the range that individual users might experience in a particular situation.

40 km (25 mi):	• Hilly terrain	• Light pedalling	• High pedal assist level, high twist power assist use
	• Windy	• Heavy payload	
52 km (32 mi):	• Flat terrain	• Light pedalling	• Low pedal assist level, minimal twist power assist use
	• Not windy	• Normal payload	

- 88 km (55 mi):
- Flat terrain
 - Not windy
 - Moderate to heavy pedalling
 - Normal payload
 - Low pedal assist level, minimal twist power assist use

Best practices for extending range and battery life

Follow the best practices listed below to help extend your range and battery life.

- Whenever possible, avoid applying full twist power assist when the RadRunner has slowed to very low speeds, has stalled, or stopped.
- Pedal to assist the motor when climbing hills and accelerating from a stop.
- Do not climb hills steeper than 15% in grade.
- Avoid sudden starts and stops.
- Accelerate slowly.
- Avoid riding in extremely cold or hot temperatures.

Battery storage

When storing your ebike from Rad Power between rides, follow the recommendations below to maintain the health and longevity of your battery.

- Power off the battery either locked to the frame or unlocked and removed from the frame for storage. (see [“Start-up procedure” on page 23](#) for key-position details.)

SHORT-TERM STORAGE TEMPERATURES

Store the battery in a dry, indoor location between -10°C to 25°C (14°F to 77°F).

! DANGER: Storing your battery above 55°C (131°F), such as in a hot car in direct sunlight, can cause permanent range decline or critical failure, and could lead to electrical fire, serious injury, or death.

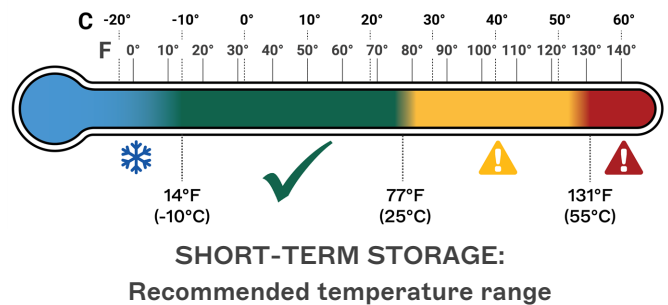

LONG-TERM STORAGE TEMPERATURES

For long-term storage (more than two weeks), choose a dry, indoor location. The ideal minimum temperature for long-term storage is a bit warmer than what’s allowable for short-term storage. Make sure your battery stays between 5°C to 25°C (40°F to 77°F).

LONG-TERM STORAGE TIPS

- For long-term storage, we recommend that you keep your battery at approximately 40-70% charged. Check the battery’s charge level monthly. If necessary, use the charger from Rad Power Bikes to charge the battery to about 40-70% charged.

! CAUTION: Long-term storage of your battery at temperatures above 35°C (95°F) or below 5°C (40°F) can reduce battery performance and lifespan.

! CAUTION: Don’t store your battery long-term at full charge, zero charge, or very little charge. Storing your battery for long periods at *full charge* can cause range decline over time. Storing your battery for long periods at *very little or no charge* can cause permanent range decline or a non-functional battery.

Summary: Battery recommended temperatures

The temperatures listed below represent *ambient* temperatures. Internal battery temperatures are likely to be higher than ambient temperature during charging and use. The battery will automatically turn off to prevent damage when

its internal temperature reaches below -15°C (5°F) or above 55°C (131°F). Please see the preceding sections for more information.

Recommended operation (riding) range: -15°C to 40°C (5°F to 105°F)

Recommended charging range: 5°C to 25°C (41°F to 77°F)

Recommended short-term storage range: -10°C to 25°C (14°F to 77°F)

Recommended long-term storage range: 5°C to 25°C (40°F to 77°F)

Additional critical battery safety information

You must read and understand all safety-related messages in this section before handling, using, charging, or storing the battery that came with your RadRunner.

- Always remove the key from the keyport of the battery before riding. Do NOT operate the ebike with the key in the keyport, or injury to your leg or damage to the electrical system can occur.
- Avoid salt water and de-icing compounds, which are very corrosive and can lead to damage, especially if they come in contact with the battery and its mount. Never ride through standing salt water, e.g., through waves at a beach.

 **DANGER:** Never open the battery housing, which can expose you to caustic substances and electrical shock. It can also create a fire hazard, which can lead to serious injury or death. Opening the battery housing may void the warranty.

 **WARNING:** Never immerse or submerge the battery in water or liquid, including water in the battery mount, which can cause damage, serious injury, or death. If the battery was immersed or submerged in water or another liquid, do not use the battery.

 **CAUTION:** Using aftermarket battery accessories or products that have not been tested by Rad Power Bikes for safety and compatibility may void your warranty, result in ebike or property damage, create a safety hazard, or cause injury. If you use products not tested and recommended by Rad Power Bikes, you do so at your own risk.

 **NOTICE:** When the battery is off its mount, protect the battery terminal contacts from damage or exposure to harmful substances including liquids and salt. Do not touch the terminal contacts. If the terminals become damaged, please discontinue use and contact Rad Power Bikes Product Support immediately.

 **NOTICE:** Always follow any safety information attached to the battery or charger. A sample label for the battery that shipped with your ebike is shown at right, manufacturing location and other details may differ. Do not remove this label from the battery.

Operation

WARNING: Incorrect assembly, maintenance, or use of your ebike can cause component or performance failure, loss of control, serious injury, or death. Even if you're an experienced bike rider, **you must read and understand the entire manual and any documentation provided for subcomponents or accessories before riding.** If you are not sure you have the experience, skills, and/or tools to correctly perform all assembly steps in the manual and the assembly video at radpowerbikes.eu/manual, have a local, professional, reputable bike mechanic assemble your ebike.

How the electrical system works

Your RadRunner is equipped with two ways for a rider to use power assistance from the motor forwards: a pedal assist system (PAS) and a twist power assist.

WARNING: Practise using the pedal assist (PAS) and twist power assist in a flat, clear, open area until you understand how these power sources work together. Failure to understand how to safely operate the PAS and twist power assist together can result in loss of control, crash, injury, and/or death.

HOW PEDAL ASSIST WORKS

You can use the pedal assist system (PAS) to call up assistance from the motor *while you are pedalling*.

Pedal assist uses a cadence sensor built into the drivetrain of the ebike. The cadence sensor detects when you revolve the pedals and signals the electric motor to provide the level of pedal assistance (0-4) that you selected.

HOW THE TWIST POWER ASSIST WORKS

To engage the twist power assist while pedalling, slowly and carefully rotate the twist power assist grip backwards towards yourself. When the bike is on and you are pedalling at an adequate cadence, the twist power assist function acts as an adjustable, on-demand pedal-assistance boost. It is not designed to be used when the rider is not pedalling.

NOTICE: Twist power assist and motor use may not be allowed in all areas. It is your responsibility to know and follow ebike regulations, rules, and traffic laws where you ride.

MOTOR SOUND LEVELS

The motor on your new ebike is designed to meet EU noise requirements. The A-weighted emission sound pressure level at the driver ears is less than 70 dB(A).

Battery key positions

Familiarize yourself with the keyport and key positions before riding the bike. **Always remove the key before getting on your bike to ride it.**

- Any time the battery is in key position A, (power on, battery locked to the frame) the power button on the LED display will turn the bike on and off, and the battery cannot be removed.
- If the battery is in key position B, (power off, battery locked to the frame) no buttons or controls can be activated, the bike will remain off, and the battery cannot be removed.
- Any time the battery is in key position C, (power off, battery unlocked from the frame) the battery must be removed from the bike before moving or riding the bike. Ensure the key is removed before sliding the battery out of the mount.

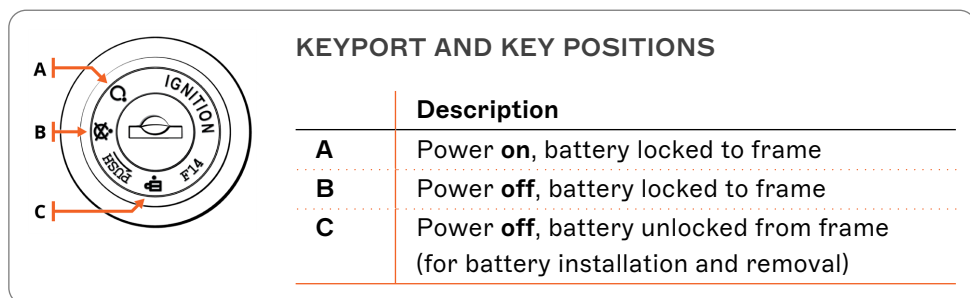



CAUTION: An unlocked or improperly attached battery can fall off a moving ebike, causing damage or injury. Always check that the battery is properly attached and locked to the frame before moving or riding your ebike.

Handlebar features

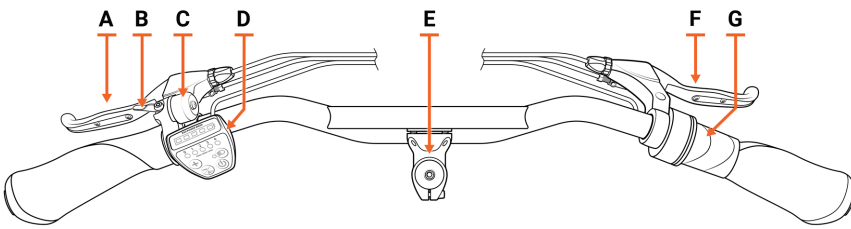

A	Left brake lever (for front brake)
B	Lever for bell
C	Bell
D	LED display
E	Stem
F	Right brake lever (for rear brake)
G	Twist power assist

Electrical controls and operation

Using the LED display, you can power your bike on or off and control other electrical functions.

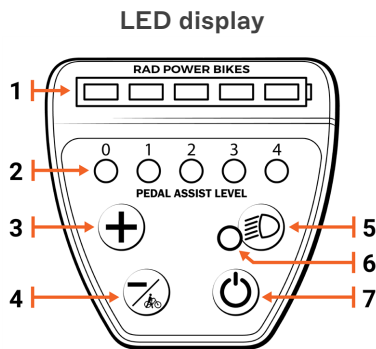

1	Battery level indicator lights	Illuminate when bike is on.
2	Pedal assist level / Error indicator lights	Illuminate when bike is on. For error code info, see “Troubleshooting” on page 37.
3	Increase pedal assist (PAS) level	Press and release to increase PAS by one level.
4	Decrease pedal assist level / Walk mode	Press and release to decrease PAS by one level. Walk mode: While dismounted, press and hold to engage walk mode.*
5	Light button	Press and release to turn headlight/taillight on/off.
6	Headlight & taillight “on” indicator	Illuminates when lights are on.
7	Power button	Press and release to turn bike on/off.

* For more information on walk mode, please visit our Help Centre at radpowerbikes.eu/help.



CAUTION: Using walk mode inappropriately can cause you to lose control of the ebike, causing ebike damage or injury. Use walk mode only while dismounted from the ebike, with both hands on the handlebar, and with at least one hand on a brake lever so that you can quickly cut off power to the motor if necessary.

Headlight operation

The headlight and taillight on the RadRunner will illuminate when the bike is powered on, as a default safety feature. We recommend riding with the headlight on, even during daylight. The headlight can be turned off for daytime riding by pressing and releasing the headlight button once the bike has been powered on.

The headlight on the RadRunner is designed to help others see the bike, especially in low-light conditions. Depending on rider preference and visual ability, an additional bike light may be necessary to illuminate the path ahead for the rider.

Brake light

The RadRunner is equipped with a taillight/brake light that is integrated into the electrical system. When you turn on your ebike, both the headlight and taillight will illuminate to make you more visible to other vehicles. Any time the ebike is powered on, squeezing one or both brake levers on the handlebar will activate the brake light, causing the taillight to illuminate additional areas.

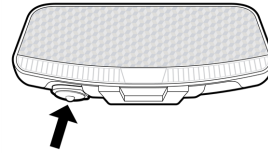

The flash mode button is on the bottom left of the taillight housing.

The taillight also has a “flash mode” you can activate. To do so, power on the ebike, and then, while dismounted from the ebike, press the rubber flash-mode button on the bottom left side of the taillight housing. When in flash mode, the taillight will flash continuously, and squeezing the brake lever(s) will illuminate a brighter, solid brake light. Flash mode will continue if the headlight is turned off. But if you turn the ebike off and back on, you’ll need to re-activate flash mode.

NOTICE: Flashing lights may not be legal in some areas. It is your responsibility to know and obey all applicable laws where you ride your ebike.

Start-up procedure

Before you can take your first ride you need to have properly assembled your ebike, tightened all components correctly, read this entire manual, and had a professional, reputable bike mechanic check the assembly. You also need to be at least 16 years old, and don’t forget to put on a helmet.

 MINIMUM OPERATOR AGE	 WEAR A HELMET	 PRE-RIDE CHECK rad-go.com/safety
--	--	--

Follow these steps to ride Rad!

1. **Run through the safety checks** outlined in [“Safety checklists” on page 29](#)

2. **Familiarize yourself with the key positions.** The [“Keypoint and key positions”](#) illustration shows the key-port in position B, in line with the small circle icon with an “X” through it. In key position B, the battery power is off and battery is locked to the frame.

KEYPORT AND KEY POSITIONS	
	Description
A	Power on, battery locked to frame
B	Power off, battery locked to frame
C	Power off, battery unlocked from frame (for battery installation and removal)

3. **Check that the battery is locked securely.** Ensure the keyport is aligned with the circle containing an “X,” in the “Power off, battery locked” position (B) as explained above. If needed, insert the key and align with the “Power off, locked” icon (B). Remove the key and carefully use both hands to pull up on the battery to test that the lock is secure.



CAUTION: Getting onto the ebike or riding it with the key in the battery can cause injury to your leg and damage to the key or lock mechanism. Always remove the key before riding the ebike.

4. **Turn on the ebike.** With the battery locked in place, insert the key and turn clockwise to the open circle icon, which is the “Power on, battery locked to frame” position (A), as shown in the image above. Remove the key by pulling directly backwards without twisting so the key position remains in the “Power on, battery locked to frame” position. Locate the LED display (near the left handlebar grip). Hold down the power button for approximately two seconds until power is delivered to the LED display and the headlights turn on.



CAUTION: Do not confuse your keyport and the charging port. Do not insert your key into the charging port. Inserting anything into the charging port other than the charging plug can damage the battery.

5. **Try out your bell** if you haven’t already! It’s an important safety tool for alerting others to your presence, especially when passing. The bell is integrated into the left brake lever on your handlebar. To ring it, flick the bell lever;

see the illustration [“Handlebar features” on page 22](#).

6. **Select your desired level of pedal assistance (PAS)** from 0 through 4 using the up and down arrows on the LED display. Level 0 provides no pedal assistance, level 1 provides the lowest amount of pedal assistance, and level 4 provides the highest amount. Start in PAS level 0 or 1 and increase PAS levels one at a time as you get comfortable.
7. **Begin riding carefully.** With the proper safety gear and rider knowledge, you may now operate your ebike from Rad Power Bikes. Start pedalling on flat ground, clear of obstacles and people, with the ebike at pedal assist level 0 or 1. You may also use the twist power assist to accelerate and maintain your desired speed.

NOTICE: While you're getting to know your ebike, don't ride with passengers or cargo (see [“Carrying cargo or a passenger” on page 26](#) for more information). Review, understand, and follow the safety information in [“Ride as safely as possible” on page 40](#).

8. **Use the twist power assist** (next to the right handlebar grip) by slowly and carefully rotating it towards the rider. Do not use the twist power assist unless you're on the bike, and note that the twist power assist can be activated with a twist any time the bike is powered on.



WARNING: Be careful not to accidentally twist the twist power assist, which can cause sudden acceleration. If you're not prepared for this acceleration, you can lose control of the ebike, which can lead to serious injury or death. To minimize this risk, always keep at least one hand ready to squeeze the brake lever to cut off power to the motor. When you dismount, power off the bike before moving it.



WARNING: Engaging the pedal assist feature, especially at a high setting, will cause acceleration that may be greater than expected, especially for relatively new riders, and that can cause loss of control, serious injury, or death. To minimize risk, start at PAS level 0 or 1.

Parking, storage, and transport

Please follow these tips to ensure your ebike is well cared for when you're not using it.

PARKING AND STORAGE

- Park in accordance with local rules and regulations, especially if you're in a public place.
- Park indoors whenever possible. If you must park outdoors in rain or wet conditions, do not do so for an extended period of time, and afterwards park in a dry location to allow the ebike systems to dry out. When any bike or ebike is exposed to wet conditions, it will need more frequent maintenance to prevent rust and corrosion and to ensure all systems work safely. See [“Guard against rust, corrosion, and water damage” on page 36](#).
- Avoid parking or storing your ebike in direct sunlight, which can cause damage to electrical components.
- Do not park or store your ebike in excessive heat, such as inside of a parked car on a hot day. Always store your ebike within this temperature range: -10°C to 25°C (14°F to 77°F).



DANGER: Storing your battery above 55°C (131°F), such as in a hot car in direct sunlight, can cause permanent range decline or critical failure, and could lead to electrical fire, serious injury, or death.

- Switch the power and any lights off to conserve battery power. Remove the key from the ebike and ensure the battery is locked to the frame in the off position or use the key to remove the battery and bring it with you for security.
- Register your ebike with a regional bike registry (ask your local bike shop for recommendations) to increase the chance you'll get your ebike back in the unfortunate event it's stolen.
- Lock up your ebike to reduce risk of theft. You can purchase a lock from our website at radpowerbikes.eu or consult a local bike shop.

TRANSPORTING

- When pushing or carrying the ebike, turn off the power to avoid accidental acceleration from the motor, e.g. by mistakenly twisting the twist power assist. Another option is to keep the ebike powered on and use “walk mode”—see [“Electrical controls and operation” on page 22](#) for more information.

- Only use racks (i.e., a bike rack for your car or other vehicle) designed for the size and weight of your ebike. Pay particular attention to whether the rack can accommodate the width of your ebike tyres.
- When carrying your ebike on a rack for transport, remove the battery, and place/wrap it securely inside your vehicle, making sure it can't roll around and that its plugs and contacts are protected. This will reduce the weight of the bike, make lifting and loading it easier, and keeps your battery safer.
- Do not leave a battery in direct sunlight or any location that is or may become excessively hot or cold, like a parked car, for extended periods.
- Before using public transportation (buses, trains, etc.) to transport your ebike, check with the relevant transportation authority for rules that might apply to ebikes, including weight and size limits, tyre widths, lithium-ion batteries, etc.
- Avoid transporting any electrical bike on a vehicle rack or truck bed during rain, which may cause water damage to the electrical components. See [“Guard against rust, corrosion, and water damage” on page 36](#) for more information. In any weather, it's safest to remove your battery before transporting your ebike. Carry the battery inside the vehicle, carefully placed to protect it from impacts, dirt, liquids, or other hazards.

Carrying cargo or a passenger

Carrying cargo or a passenger can help you have more fun on your ebike and replace trips you'd otherwise make with a car, which we think is rad. It also involves additional risks. You must read and understand this entire chapter and the rest of the manual plus any documentation that comes with any accessories you purchase before you ride your ebike with cargo and/or a passenger.

Your RadRunner is designed to carry a passenger on its built-in rear rack if you add appropriate accessories. Depending on the weight, age, and other characteristics of the person you wish to carry, you may need an approved child seat or other accessories as explained in [“Carrying passengers” on the next page](#).

 **WARNING:** Do not allow a passenger to ride on the rear rack without appropriate accessories. Doing so increases the risk of your passenger falling off the bike. It can also expose their body parts or clothing to the wheel, chain, or other moving parts, leading to serious injury or death.

For more information on optional accessories for your ebike, please go to radpowerbikes.eu.

 **NOTICE:** Carrying a passenger, child, or cargo may not be allowed in all areas. It is your responsibility to know and follow all applicable laws where you ride your ebike.

Weight limits

The total maximum weight limit (payload capacity) of your RadRunner, listed below, includes the weight of the operator as well as clothing, riding gear, cargo, accessories, etc. See [“Carrying passengers” on the next page](#) for more safety information about passengers.

Total maximum payload of the RadRunner: 136 kg (300 lb)

Rear rack maximum payload: 54 kg (120 lb)

Kickstand maximum payload: 45 kg (100 lb)

The maximum payload capacity and other important safety information for specific Rad Power Bikes accessories will come with those products and/or be available online at radpowerbikes.eu/help.

 **WARNING:** Never exceed the payload limit of any accessory or component of your ebike even if you attach to it an accessory that carries a higher weight limit. Overloading any component can cause component failure, loss of control, serious injury, or death.

 **WARNING:** Failure to ensure that cargo can't interfere with the operator's control of the ebike can lead to serious injury or death. The operator is always responsible for securing loads, loose straps, and gear.

Carrying loads (cargo or passengers) safely

Follow these instructions to maximize safety when using your RadRunner to carry cargo or a passenger.

LOAD AND SECURE CARGO CAREFULLY

- Hold onto the ebike when loading and carrying cargo and/or passengers. The kickstand is not designed to be used for loading cargo or passengers. Do not assume the bike is stable and balanced when using the kickstand.
- Load cargo as low as possible to keep the ebike's centre of gravity low and improve stability.
- Ensure cargo loads are properly secured and periodically check that nothing loosens, risks interfering with any moving parts, or risks touching or dragging on the ground.

 **WARNING:** Failure to ensure that cargo or a passenger can't interfere with the rider's control of the ebike can lead to serious injury or death. The rider is always responsible for securing loads, loose straps, and assessing a passenger's ability to ride safely. Please see [“Carrying passengers” on the next page](#) for more information.



WARNING: Loading cargo or a passenger without holding onto the RadRunner can cause it to tip, leading to damage or serious injury. The kickstand is designed to hold up an unoccupied, unloaded ebike on a hard, flat, level surface, not to support the weight of the rider, passengers, or cargo. Always hold onto your RadRunner when loading or unloading cargo or passengers.

PRACTISE WITH LIGHT LOADS IN A SAFE AREA

Carrying extra weight significantly affects braking, acceleration, turning, balancing, etc. These effects can be increased by challenging riding conditions, such as when roads are wet or slick. Hills that are normally easy to climb or descend without cargo can become challenging or even dangerous once extra weight is loaded onto the ebike.

Extra weight will also increase the time it takes to slow the ebike when braking.



WARNING: Carrying cargo or passengers significantly affects braking, acceleration, turning, and balancing, which can increase the risk of falls and other accidents, potentially leading to property damage, serious injury, or death. To minimize such risk, practise riding with light cargo in a flat, open area before attempting to carry heavier cargo or passengers, especially on roads or hills and in wet conditions.

USE BOTH BRAKES

With extra weight on your ebike, it's more important than ever to use both front and rear brakes, and always engage the rear brake first to prevent excessive strain on the front wheel and fork and to prevent loss of control. Ensure both front and rear brakes are properly adjusted, maintained, and applied.



WARNING: Using the front brake by itself can cause excessive stress on components, damage to the ebike and parts, loss of control, injury, or death. Always apply the rear brake before applying the front brake, using both brakes for all operations.

ADJUST YOUR ROUTES AND SPEED

When carrying heavy loads or passengers, plan your routes to avoid challenging hills and other hazards. Ride more slowly, and leave more time and distance for braking.

Carrying passengers

Your RadRunner is designed to carry one operator (age 16 or older) and a maximum of one passenger. A passenger will require certain accessories in order to ride safely on the bike. What accessories they need (e.g., an approved child seat, the Passenger Package, etc.) will depend on their size, age, and other characteristics. When carrying passengers on your RadRunner, be sure to follow the recommendations in [“Carrying loads \(cargo or passengers\) safely” on the previous page](#) as well as the recommendations below. Ensure that the operator and any passenger are wearing a properly fitted and approved helmet.

- Always use the Passenger Package and any other passenger accessories required for the age, weight, and ability of the passenger you wish to carry. It is not safe for passengers to ride on the rear rack without appropriate accessories. Please refer to the accessory-specific information at radpowerbikes.eu for the passenger accessories available for your RadRunner.
- When carrying a child, you must ensure that child meets the criteria for an approved child safety seat (the Thule Yepp Maxi child seat). Refer to the seat manufacturer's instructions for more information on passenger criteria (www.thule.com). Otherwise, you must have the Passenger Package installed, including the wheel skirts, passenger foot pegs, and the passenger seat.
- To use the Passenger Package, a passenger must be tall enough to rest their feet on the passenger foot pegs, and they must be able to refrain from standing on those foot pegs, which have a payload capacity of 14 kg (30 lb) per side. Please refer to the safety guidelines online for the passenger accessories available for your RadRunner.
- Use fenders with the Passenger Package. A properly installed rear fender will help keep hands and feet clear of the spinning wheel.
- Do not allow anyone to stand or kneel on the rear rack or any other bike components.
- A passenger should sit directly over or forwards of the rear wheel, and no more than 18 kg (40 lb) should be loaded over the rear 1/3 of the rear rack.
- Do not allow anyone to sit sideways or backwards on the rear rack.

DANGER: Using your RadRunner to transport a passenger who is not the appropriate size or age for your child seat, or who does not have the health, motor control, or impulse control to ride safely as a passenger, can lead to serious injury or death of the operator and/or passenger. Read and understand the specifications of any child seat you purchase and all safety-, cargo-, and passenger-related information in this manual. It is your responsibility to assess the ability of a potential passenger to ride safely. If you're not certain, consult a physician.

DANGER: Leaving a child unattended on a bicycle creates a VERY HIGH RISK of the bike tipping over, causing serious injury or death. Always remove your child from the bike before you look away or walk away from the bike.

WARNING: To reduce the risk of injury, always closely supervise children if and when you use your RadRunner near them.

WARNING: Serious injury or death can occur if clothing or body parts contact either wheel or other moving parts while the bike is in motion.

WARNING: If your ebike or a passenger accessory package came with rear wheel skirts, do not remove them. Removing these skirts can cause passenger hands, feet, clothing, or loose items to get caught in the rear wheel, which can lead to damage, injury, or death. Ensure hands, feet, loose straps, and other cargo are always kept away from wheels and the drivetrain when the bike is in motion.

USING A CHILD SEAT FOR SMALL CHILDREN

Your RadRunner is designed to work with the Thule Yepp Maxi child seat, which can attach to the “Yepp window” on your RadRunner’s built-in rear rack.

For installation instructions, safety notices, age/weight requirements, general information, and tips on safe operation of the Thule Yepp Maxi child seat accessory, visit the manufacturer’s website online at www.thule.com or visit the Rad Power Bikes Help Centre at radpowerbikes.eu/help.

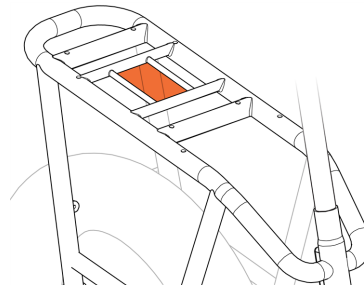

Thule Yepp mounting window (highlighted in orange) on the RadRunner rear rack.

Carrying pets

Rad Power Bikes understands that you may want to bring your pet along on your ebike adventures, and we think that’s rad. We cannot recommend any pet carrier or restraint system that we have not tested for compatibility and safety with your ebike from Rad Power Bikes.

WARNING: Transporting a pet using any bike or ebike puts you and your pet at risk of injury or death, especially if the pet distracts you, affects your balance, interferes with moving ebike parts, or causes you to exceed your ebike’s or a component’s maximum weight capacity, etc. It’s impossible to anticipate every situation that can occur while riding with a pet. If you carry a pet on any bike, ebike, or similar vehicle, you assume any and all inherent risks.

WARNING: The ebike operator is always responsible for assessing a pet’s ability to ride safely. Using this product to transport a pet that does not have the health and temperament to ride safely can lead to serious injury or death of the operator and/or pet(s). Consult a veterinarian or pet behavior specialist if you have any questions or concerns.

WARNING: Never leave a pet unattended in a pet basket carrier or other appropriate pet accessory on the ebike. Leaving pets unattended on the ebike creates a VERY HIGH RISK of the pet trying to escape or the ebike tipping over, leading to damage, serious injury, or death.

Safety checklists



WARNING: Any bike, ebike, or similar vehicle is subject to wear and tear, and certain components and fasteners can stretch or loosen with the vibrations and stress of normal operation. **You must check your ebike before each ride** and according to the other checklists in this manual. Failure to do so could result in property damage, serious injury, or death.



PRE-RIDE CHECK
rad-go.com/safety

BEFORE YOUR FIRST RIDE

- Make sure handlebar cables were routed correctly when the handlebar was installed. Turn the handlebar fully to the left and right and make sure this doesn't pull any of the cables or wires taut.
- Make sure your pedals are secure using a pedal wrench or a torque wrench fitted with a crowfoot bit. Torque according to the values listed in [“Tools and torque specifications” on page 11](#).
- Check that the cable connectors on the ebike are all plugged in securely and that nothing loosened in shipping.
- Check the brake functions per [“Checking brakes & motor cutoff switches” on page 33](#), but note that brakes can rub a little the first few times you ride. This is okay and normal; any squeak or noise should go away with use.
- Check everything on the “Before every ride” list below.

BEFORE EVERY RIDE

Before every, follow the safety checklist in the table below. On very long rides, check every ride or every 40–72 km (25–45 miles). If you find anything amiss with your ebike, don't ride it until you're sure it's fixed. Consult a local, professional, reputable bike mechanic or explore our Help Centre at radpowerbikes.eu/help if you have any questions.

Fasteners

- Ensure all fasteners are correctly tightened according to [“Tools and torque specifications” on page 11](#).
- Check that all quick-release levers, including the quick release on the front wheel and the seatpost, are tight and properly secured. Ensure the front wheel quick-release lever is positioned so that the front fork lower doesn't prevent it from closing fully.
- Check that the fasteners on any accessories you've added are properly tightened according to the manufacturer's instructions.

Brake system

- Check brake pads and ensure the brake pad material isn't thinner than the backing plate it attaches to.
- Ensure brake pads are correctly positioned in relation to the brake rotors.
- Ensure brake cables are lubricated, correctly adjusted, and show no obvious wear.
- Ensure brake levers are properly positioned and tightly secured to the handlebar.
- Ensure the brake lever tension is appropriate.
- Check that the taillight brightens when you squeeze each brake lever.
- Use the techniques in [“Checking brakes & motor cutoff switches” on page 33](#) to test the brake levers, brakes, and motor cutoff switches.

Drivetrain: cranks, pedals, chain, chain tensioner

- Ensure pedals are securely tightened to the cranks, that cranks are not bent, and that cranks are securely tightened to the bottom bracket. See [“Tools and torque specifications” on page 11](#).
- Ensure the chain is clean, lubricated, and runs smoothly. Take extra care with chain maintenance if the ebike is used in wet, salty, dusty, or otherwise damaging conditions.
- Check that the chain tensioner is aligned and functioning properly.

Motor drive assembly & twist power assist

- Ensure the hub motor is spinning smoothly and is in good working order.
- Ensure the power cable running to the hub motor is secured and undamaged.
- Check the axle nuts to ensure they are correctly tightened (see [“Tools and torque specifications” on page 11](#)).
- Ensure the torque washers, torque arm, and torque arm bolt are in place and secured.

- Ensure the twist power assist and pedal assistance are operating normally.

Steering

- Ensure the handlebar and stem are correctly aligned, adjusted, and tightened for proper steering.
- Perform the tests in [“Handlebar twist and push tests” on page 35](#).
- Ensure the handlebar grips are secure and undamaged.

Bearings

- Check that headset, wheel, pedal, and bottom-bracket bearings are lubricated, run freely, and display no excess movement, grinding, or rattling.

Wheels and tyres

- Ensure tyres are holding air and inflated to within the PSI limits displayed on the tyre sidewalls.
- Ensure tyres have good tread, have no bulges or excessive wear, no cracks, and are free from any other damage or foreign objects.
- Ensure rims run true and have no obvious wobbles, dents, or kinks. See [“Tyre and wheel care” on page 34](#).
- Check each wheel spoke. If any are loose or broken, seek help from a professional, reputable mechanic.
- Check the security of all wheel mounting hardware (wheel axle nuts, quick-release levers). Check wheel security and hardware torque on a regular basis (see [“Tools and torque specifications” on page 11](#)). Wheels can become loose or unsecured with normal use.



WARNING: An improperly secured front or rear wheel can cause loss of control, accidents, serious injury, or death. Check that the wheels are properly secured during assembly and before each ride.

Frame, fork, and seat

- Check that the frame and fork are not bent or broken.
- Check that the seat is adjusted properly, that the seatpost quick-release lever is securely tightened, and that the seat does not move when the lever is closed. Ensure that the seatpost minimum insertion marking is fully inserted into the frame.

Battery

- Ensure the battery is charged.
- Ensure there is no damage to the battery.
- Lock the battery to frame and check that it is secured. Remove the key before riding.
- Ensure the battery gauge on the LED Display and the charge status indicator on the battery read similarly.

Cables

- Look over electrical cable connectors to make sure they are fully seated and free from debris or moisture.
- Check cables and cable housing for obvious signs of damage.
- Ensure cables are secured away from moving parts.
- Ensure headlight, taillight, and brake light are functioning, adjusted properly, and unobstructed.

Accessories & safety gear

- Ensure all reflectors are properly fitted and not obscured.
- Ensure all accessories and components installed on the ebike are properly secured and functioning according to their manufacturer's specifications.
- Check all safety gear, clothing, cargo, and accessories for loose or potentially loose elements and secure them.
- Ensure rider and any passengers are wearing a helmet and other required riding safety gear, and inspect these items for signs of damage.
- If your ebike has fender/mudguards: Ensure they are centred over the wheels, adjusted properly, properly secured (see [“Tools and torque specifications” on page 11](#)), and have no cracks or holes.



WARNING: Riding your ebike when any component's useful life is surpassed can cause that component to fail, resulting in loss of control, serious injury, or death. Pay attention to signs of wear such as cracks, scratches, component colour change, and operational changes that could indicate a component needs replacing. Before each ride, check your ebike using the [“Safety checklists” on page 29](#). Perform regular maintenance according to [“Recommended service intervals” on the next page](#). If you're not sure you have the experience, skills, and tools to perform safety checks and regular maintenance, consult a professional, reputable bike mechanic for help.

AFTER EVERY RIDE

- Store your ebike and battery in a dry location and follow the advice in [“Parking, storage, and transport” on page 24](#).
- Guard against damage from the elements. See [“Guard against rust, corrosion, and water damage” on page 36](#).
- Charge your battery in a dry, indoor location according to the directions in [“Battery information” on page 15](#).

Maintenance

Follow these maintenance guidelines to ensure your RadRunner stays safe and fun to ride.

Check and service your ebike regularly

On any bike or ebike, certain parts need to be replaced periodically due to wear, and sometimes parts become damaged for various reasons. Check your ebike before each ride by following the directions in [“Safety checklists” on page 29](#). Have your ebike regularly serviced by a professional, reputable bike mechanic. See [“Recommended service intervals” below](#) for more information.

Components of any electrical bike are subject to higher wear compared to the components of bikes without power assistance. This is because ebikes can travel at higher average speeds than regular bicycles and generally weigh more. Higher wear is not a defect in the product and is not subject to warranty. Typical components affected are the tyres, brake pads and rotors, forks, spokes, wheels, and the battery.

If you need to replace a part on your ebike, visit radpowerbikes.eu. If you want something that isn't listed there, contact Rad Power Bikes Product Support. Be extremely careful about using parts or accessories that Rad Power Bikes has not tested for safety and compatibility with your specific product.

 **WARNING:** Using aftermarket accessories or components (trailers, stands, vehicle racks, etc.) that have not been tested by Rad Power Bikes for safety and compatibility with your specific ebike may void your warranty, create an unsafe riding condition, result in ebike/property damage, or cause serious injury or death. If you use replacement parts or accessories not tested and recommended by Rad Power Bikes, you do so at your own risk.

Recommended service intervals

Regular maintenance of any bike or ebike is key to ensuring the best possible performance and reducing wear and tear on systems. Ideal service intervals vary depending on use conditions. We generally recommend inspections, service, and necessary replacements be performed at the time and distance intervals described below, but you should have your ebike serviced more frequently if you ride aggressively, with heavy payloads, or in harsh conditions. Have your ebike inspected immediately if you notice problems or your ebike has been involved in a fall or other accident.

 **WARNING:** Have your ebike inspected by a professional, reputable bike mechanic after any fall, crash, or accident, as these can cause damage (visible or internal/not readily apparent), make your ebike unsafe, and lead to serious injury or death. Be particularly cautious about using a battery that has experienced a significant impact from a fall or crash; a damaged battery may not show external signs of damage. Using a damaged battery or charger can create additional ebike damage or a fire hazard. For more information, see [“Battery information” on page 15](#).

AFTER BREAK-IN PERIOD OF 80–160 KM (50–100 MILES)

- Inspect**
- Check all cables and the chain for stretch.
 - Check spoke tension and the trueness of the wheels.
 - Check all bolted connections for loosening and ensure they are tightened to recommended torque values (see [“Tools and torque specifications” on page 11](#)).
- Service**
- Have a professional, reputable bike mechanic perform a thorough tune-up.

 **WARNING:** Certain components can stretch or loosen during any bike or ebike's break-in period, which can lead to component failure and potential injury or death. Be sure to have a professional, reputable bike mechanic perform a thorough tune-up after this break-in period or sooner if you notice any problems or if you ride aggressively, with heavy payloads, or in harsh conditions.

WEEKLY, 160–320 KM (100–200 MILES)

- Inspect**
 - Check hardware for proper torque—see [“Tools and torque specifications” on page 11](#).
 - Check drivetrain for proper alignment and function (including chain, freewheel, chainring, and chain tensioner).
 - Check wheel trueness and spoke tension, and check for quiet wheel operation (without spoke noise).
 - Check frame for any damage.
- Service**
 - Clean frame by wiping frame down with damp cloth.
 - If needed, adjust the brake tension.
 - Clean and grease the chain. More information is available online at radpowerbikes.eu/help.
- Replace**
 - Replace any components confirmed to be broken or damaged beyond repair by Rad Power Bikes Product Support or a professional, reputable bike mechanic.

MONTHLY, 400–1200 KM (250–750 MILES)

- Inspect**
 - Check brake pad wear, alignment, and the brake lever tension.
 - Check chain stretch.
 - Check chain alignment and drivetrain functioning.
 - Check brake cables for corrosion and fraying.
 - Check wheel trueness and spoke tension, and check for quiet wheel operation (without spoke noise).
- Service**
 - Clean and lubricate drivetrain.
 - Check crankset and pedal torque.
 - Clean brake cables.
 - Tension spokes and true wheels if any loose spokes are found.
- Replace**
 - Replace brake cables if necessary.
 - Replace brake pads if necessary (typically when the pad material is thinner than the backing plate).

EVERY 6 MONTHS, 1200–2000 KM (750–1250 MILES)

- Inspect**
 - Inspect drivetrain (chain, chainring, freewheel, and chain tensioner).
 - Inspect all cables and housings.
- Service**
 - Standard tune-up by professional, reputable bike mechanic.
 - Grease bottom bracket.
- Replace**
 - Replace brake pads.
 - Replace tyres if necessary.
 - Replace cables and housings if necessary.

Checking brakes & motor cutoff switches

All vehicles, including your RadRunner, need reliable brakes. Test your brake levers, brakes, and motor cutoff switches for proper functioning before every ride. If anything seems wrong, take your ebike to a local, professional, reputable bike mechanic, refer to our Help Centre (radpowerbikes.eu/help), or contact Rad Power Bikes Product Support.



WARNING: Touching the brake rotor, which has sharp edges and can get very hot while you're riding, can cause serious injury, slicing damage, or burns. The brake rotor heats up from normal friction when the brake pads press against the brake rotor to slow or stop the ebike. Touching the brake rotor with bare skin can also transfer natural oils to the rotor, and oils or other lubricants can decrease braking performance. **Do not touch the brake rotor, especially when it's in motion or after you've been riding your ebike.** Touch the brake rotor only for necessary maintenance when it is cool, not moving, and while you are wearing gloves or using other appropriate protective equipment.



1. **Test the brake levers.**
 - a. Fully squeeze each lever, and ensure neither the front nor rear brake lever touches the handlebar grips.
 - b. Ensure both brake levers are properly lubricated. If they are, they'll be reasonably easy to squeeze without feeling as though there's grit in the mechanism. When you release them, they will immediately go back to their original position.
 - c. Make sure each lever is properly oriented and firmly secured to the handlebar.
2. **Test each brake.**
 - a. Squeeze the left brake lever to lock the front brake, and then try to push the bike forwards using the handlebar. The front wheel should not spin.
 - b. Squeeze the right brake lever to lock the rear brake. Again, push against the handlebar to try moving the bike forwards. The rear wheel should not spin.
3. **Test the motor cutoff switches.** The front and rear brake levers contain motor cutoff switches, which cut off power from the motor whenever the brakes are applied.
 - a. In a clear, open area, turn on the bike. With appropriate safety gear and clothing, sit on the bike.
 - b. Squeeze the left brake lever to engage the front brake.
 - c. Lightly apply the twist power assist. The bike should not move since the brake is applied.
 - d. Release the twist power assist.
 - e. Release the brake.
 - f. Test that the twist power assist now operates with the brake not engaged.
 - g. Release the twist power assist.
 - h. Perform steps "a" – "g" again, this time with the rear brake lever (on the right side of the handlebar).

Tyre and wheel care

The tyres and inner tubes that came with your ebike are designed for durability and safety for regular cycling activities. Wheels and tyres need to be checked before each use to make sure they're in good condition. Always replace tyres and inner tubes that have punctures, cuts, bulges, damage, or excessive wear before you ride.

TYRE INFLATION

Inflate tubes and tyres to within the PSI (pounds per square inch) range stamped onto the tyre sidewall. For additional information about tyre pressure, please consult our Help Centre at radpowerbikes.eu/help.

NOTICE: Be sure not to confuse the PSI value on your tyre sidewall with the "TPI" (threads per inch) value, which may also be listed there.



WARNING: Underinflating your tyres can result in loss of control. Overinflating can make tyres burst. Either scenario can lead to serious injury or death. Always maintain the correct air pressure of your tyres, which is listed on the tyre's sidewall, and use a regulated air source with pressure gauge so that you can measure pressure accurately.

WHEEL "TRUENESS"

Your wheels should always spin straight ("true") and must be repaired or replaced if they wobble side to side or up and down when spinning. To test them, do this:

1. Spin the wheel.
2. Brace a dull pencil against the frame or fork, with the tip just touching the rim.

If the gap between the spinning rim and pencil changes more than 5 mm, your wheels may need truing. If your wheels become untrue or if spokes loosen, which can happen with normal use, we recommend that you have a professional, reputable bike mechanic perform wheel tuning and truing operations. Do not attempt to true wheels or tighten spokes unless you have the highly specialized skills and tools to do so.

TYRE REPLACEMENT

Even tyres equipped with built-in flat-preventative tyre liners, like those that come with your RadRunner, can and do get flats from punctures, pinches, impacts, and other causes. If you get a flat tyre or see evidence of tyre wear, you must replace your tyre and/or tubes before operating the ebike again. Otherwise, you risk ebike damage, serious injury, or death.

 **CAUTION:** Removing a tube from your wheel rim before the air has been released from it can cause the tube to burst, potentially causing serious injury. Always release air pressure before removing your tube.

 **WARNING:** Aftermarket tyres or inner tubes not provided by Rad Power Bikes may not be compatible with your wheels or the performance requirements of your ebike. Such tyres can fail or create unsafe riding conditions, causing serious injury or death. Always use replacement tyres and tubes that are sized to be compatible with your ebike frame. For safety, and if required by law, ensure replacement tyres have sufficient reflective sidewall striping.

After replacing a tyre or removing the wheel for any other reason, be sure to tighten your axles according to the values listed in [“Tools and torque specifications” on page 11](#). For more information on tyre or tube replacement, visit radpowerbikes.eu/help or contact Rad Power Bikes Product Support.

Handlebar twist and push tests

 **WARNING:** An improperly secured wheel and/or handlebar stem can cause loss of control, accidents, serious injury, or death. Check that the front wheel and handlebar stem are properly secured during assembly and before each ride.

HANDLEBAR TWIST TEST

The following twist test will help you verify that your stem clamp bolts are tight enough.

1. **Get the ebike ready for testing.** Turn off the ebike, remove the battery, and press and hold the power button to discharge remaining power.
2. **Brace the front wheel.** Stand at the front of the ebike, facing the handlebar, and brace the front wheel between your feet and lower legs.
3. **Try to twist the handlebar.** Hold both handlebar grips and push forwards with one hand while pulling back with the other. Push and pull at the same time with about 9 kg of force with each hand.
4. **Ensure the handlebar and wheel stay properly aligned.** The handlebar and handlebar stem should be tightly secured, and the handlebar should be perpendicular to the front wheel.
5. **Repeat the twist test pulling/pushing with the opposite hands,** using about 9 kg of force pushing with one hand and 9 kg of force pulling with the other hand.
6. **Check for any movement or changes in alignment of the stem and handlebar relative to the front wheel.** If there was no alignment change, skip the next step, reinstall your battery, and test your ebike fully before riding. If you did *not* notice change in alignment, proceed to the next step. If you *did* detect movement, you'll need to loosen and retighten the stem clamp bolts according to the directions in the assembly instructions. Be sure to tighten your bolts according to the values listed in [“Tools and torque specifications” on page 11](#).

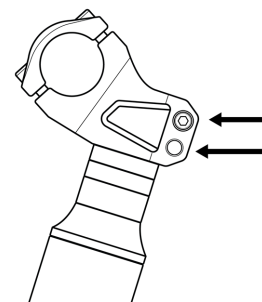

Stem clamp bolts

HANDLEBAR PUSH TEST

This test will involve applying force directly to your handlebar to see whether it could pivot unexpectedly during operation. The illustration at right shows the type of motion this procedure tests for.

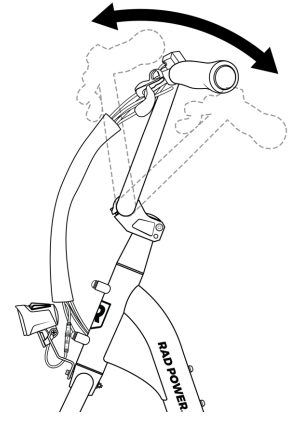

1. **Get the ebike ready for testing.** Turn off the ebike, remove the battery, and press and hold the power button to discharge remaining power.
2. **Make sure your handlebar is centered on the stem.** Your handlebar has the widest diameter at its centre. If it isn't centred, it could come loose. Centre your handlebar, loosening and retightening the stem faceplate bolts as necessary.
3. **Brace your front wheel.** Roll your ebike up to a wall so that your front wheel is touching the wall and is perpendicular to the wall. Stand over your frame as though you're about to ride it, and then sit down. If necessary, lower the seat so that you can sit on it while your feet are on the ground. Place both hands on the handlebar and squeeze the brake levers.
4. **Push your handlebar.** Begin by pushing with medium force, watching for any pivot in the handlebar. Increase the force until you are pushing as hard as you can, ideally with 45 kg of total force.
5. **If your handlebar did not pivot, it's tight enough.** If your handlebar did pivot, you will need to loosen and re-tighten the stem faceplate bolts as described in the assembly instructions. Be sure to torque the bolts according to ["Tools and torque specifications" on page 11.](#)



WARNING: Improperly securing your handlebar, stem, or stem riser can result in loss of control of your ebike, serious injury, or death. If you are not sure you have the experience, skills, and tools to correctly perform all steps to secure and verify the security of the handlebar, front wheel, and handlebar stem you MUST consult a professional, reputable bike mechanic to check your work and/or secure those components to the ebike properly.

Guard against rust, corrosion, and water damage



WARNING: Damage to your ebike's electrical system caused in any manner, including water intrusion, can lead to battery failure, electrical system malfunction, or electrical fire and consequent property damage, injury, or death. Follow all instructions to minimize chance of water damage. If you have any questions, contact Rad Power Bikes Product Support.

Like any vehicle used outdoors, your RadRunner needs care to ensure it isn't damaged by the elements. Follow these steps for a long, healthy life for your ebike:

- Store under shelter and in an upright position; avoid leaving the ebike in the rain or exposed to corrosive substances such as water, salt, or de-icing substances. If exposed to rain, dry your ebike afterwards, and apply an anti-rust treatment to the chain and other unpainted steel surfaces.
- To clean your ebike, turn it and the battery off and wipe the frame with a clean, damp cloth. If needed, apply a mild, non-corrosive detergent mixture to the damp cloth and wipe the frame. Dry by wiping with a clean, dry cloth. **Never use high-pressure water on your ebike.** Wipe down your ebike frequently and wipe or spray all unpainted mechanical parts with anti-rust treatment.
- If painted metal parts become scratched or chipped, use touch up paint or nail polish to prevent rust.
- **Never immerse or submerge the ebike or any components in water or liquid, which can damage the electrical system.**
- Avoid riding on the beach, in coastal areas with high-salinity fog, or on surfaces treated with salt or de-icing compounds. Doing so exposes your ebike to salt or other substances that are very corrosive. Corrosion of electrical components can lead to permanent damage that can cause battery failure, electrical system failure, or electrical fire. Damage from corrosion is not covered under warranty.

Troubleshooting

Problem	Most common solutions
---------	-----------------------

Ebike doesn't work:

Insufficient battery power	Charge the battery
Battery is in ship mode	End ship mode by pressing and holding the battery button for at least three seconds (feature available on models)
Battery not fully seated in tray	Install battery correctly
Faulty connections	Clean and reconnect connectors
Improper turn-on sequence	Turn on ebike with proper sequence
Brake is squeezed	Disengage brake
Walk mode stopped	Ensure nothing is keeping any button(s) other than the walk mode button pressed on the UI Remote (on some models)
UI button(s) held	Ensure nothing is keeping any button(s) pressed on the UI Remote (on some models)
Discharge fuse issue	Replace 40A discharge fuse *

Irregular acceleration and/or reduced top speed:

Insufficient battery power	Charge or replace battery
Unexpected PAS level setting	Check PAS level
Loose or damaged twist power assist	Replace twist power assist

When powered on, the motor does not respond:

Loose wiring	Reconnect or replace cable(s)
Loose or damaged twist power assist	Tighten or replace twist power assist
Loose or damaged motor cable	Reconnect or replace motor cable
Damaged motor	Replace motor

Reduced range:

Low tyre pressure	Check for tyre punctures or other damage. Inflate tyres to PSI stamped on sidewall.
Low battery	Charge battery
Driving with too many hills, headwind, braking, or excessive load	Assist with pedals or adjust route
Battery discharged for long period without regular charges	Recharge the battery. If range decline persists, consult our Help Centre at radpowerbikes.eu/help .
Brakes rubbing	Adjust the brakes
Faulty, damaged, or aged battery	Contact Rad Power Bikes Product Support to replace battery. Disconnect and store damaged battery in a safe location and recycle or dispose of as soon as possible according to local rules.

The battery won't charge:

Charger not well connected	Adjust the charger connection
Charger damaged	Replace the charger

Battery damaged	Immediately stop use. Disconnect and store battery in a safe location and recycle or dispose of as soon as possible according to local rules. Contact Rad Power Bikes Product Support to replace battery.
Wiring damaged	Replace wiring
Charge fuse issue	Replace the 5A charge fuse (see “Fuse replacement” below)”)

Wheel or motor makes strange noises:

Loose motor cable connection	Reconnect cable
Damaged wheel spokes or rim	Repair or replace damaged component(s)
Damaged motor	Replace motor

Fuse replacement

If Rad Power Bikes or the information in [“Troubleshooting” on the previous page](#) suggests you need to replace a battery fuse, follow the instructions below. You can view these instructions with helpful animations online at radpowerbikes.eu/help.

TOOLS YOU’LL NEED

- Small flat head screwdriver or an awl
- Small needle nose pliers or a fuse puller
- A replacement blade fuse (these can be purchased at your local automotive store). Depending on your battery and which fuse was blown, you may need a 40A blade fuse (discharge fuse), or a 5A blade fuse (charge fuse).
- Electrical tape
- Replacement fuse covers from Rad Power Bikes (if using an awl)

WARNING: Do not operate the battery or ebike without intact fuse covers properly installed. Doing so significantly increases your risk of water entering your battery, which can damage the battery, lead to battery failure, or create a fire hazard, putting you at risk for serious injury or death. Using an awl or another sharp tool to remove a battery fuse cover can cause irreparable damage to the fuse cover. If your fuse covers get damaged by any means, please go to our Help Centre at radpowerbikes.eu/help to contact us and request a set of replacement fuse covers.

REMOVE THE OLD FUSE

1. **Get the bike ready for maintenance.** Turn off the bike, remove the battery, and press the power button to discharge remaining power.
2. **Set the battery on a solid surface with the fuse side facing upward.**
3. **Turn the battery key to the off and unlocked position** ("C" in the illustration below).

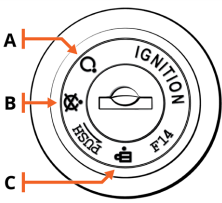

KEYPORT AND KEY POSITIONS	
	Description
A	Power on , battery locked to frame
B	Power off , battery locked to frame
C	Power off , battery unlocked from frame (for battery installation and removal)



WARNING: Do not touch the "+" and "-" terminal contacts on the bottom of the battery. Keep the terminal contacts clear of debris, and do not drop or damage the battery. If the battery is damaged, discontinue use and contact Rad Power Bikes Product Support immediately. Never open the battery housing, which may void the warranty and can result in battery damage. It can also expose you to caustic substances and electrical shock or it could create a fire hazard, which can lead to serious injury or death.

4. **Identify the fuse that needs to be removed.** The fuse rating is stamped into the battery housing just below the fuse cover. The 40A fuse is on the left and the 5A fuse is on the right.
5. **Remove the fuse cover.** Use a small flat head screwdriver or an awl to carefully pry out the fuse cover. Set the fuse cover aside.



WARNING: Use caution when using a tool to remove a fuse cover from the battery housing. Position your body so the tool points away from your body to reduce the risk of injury if the tool slips. Use caution to avoid damaging the fuse and battery casing when using a tool to remove a fuse cover from the battery housing. Insert the tool at a shallow enough angle to avoid damaging the fuse and casing near and underneath the fuse cover.

6. **Remove the fuse.** Use needle nose pliers to grip the fuse housing and pull the fuse directly outwards. If the fuse is difficult to pull, use the awl to pry each side of the fuse to rock it out the housing. Recycle the fuse according to local rules.

INSTALL THE NEW FUSE

1. **Install the replacement fuse.** Place the fuse in position and press it into the battery housing fully.
2. **Reinstall the fuse cover** if it is in good condition, or install the replacement fuse cover. Ensure the battery, the fuses, and the fuse covers are dry and free from debris.

TIP: If the fuse cover is damaged, contact us to order a replacement fuse cover. In the meantime, you can install the existing fuse cover and place a small strip of electrical tape over the fuse cover as a temporarily solution to prevent water or debris from entering the fuse port. Install the replacement fuse cover as soon as possible.

3. **Reinstall the battery,** test the bike fully before riding, and ride Rad!

Error detection

Your RadRunner is equipped with an error detection system integrated into the display and controller (see [“Electrical controls and operation” on page 22](#) for more information). In the rare event of an electrical issue with the bike, you may see a specific combination of lights flash on the Pedal Assistance Level lights on the display. If this happens, we recommend that you cease operation, take a short video of the light(s) flashing if possible, and then go to the Rad Power Bikes online Help Centre (radpowerbikes.eu/help) for more information.

The following errors are the most common and can aid in troubleshooting.

PAS lights flashing	Error type
0	Abnormal current
1	Twist power assist fault
0 and 1	Motor phase fault
2	Motor hall fault
0 and 2	Brake switch fault (or the brake was applied while turning bike on)
All lights	Communication fault

Ride as safely as possible

Operating any bike or ebike is an exciting, delightful, and practical way to get around, but like any sport, it involves risk of injury and death. By choosing to ride any bike or ebike, you assume responsibility for those risks.



WARNING: Incorrect assembly, maintenance, or use of your ebike can cause component or performance failure, loss of control, serious injury, or death. Even if you're an experienced bike rider, **you must read and understand the entire manual and any documentation provided for subcomponents or accessories before riding.** If you are not sure you have the experience, skills, and/or tools to correctly perform all assembly steps in the manual and the assembly video at radpowerbikes.eu/manual, have a local, professional, reputable bike mechanic assemble your ebike.

Age and ability requirements

You must be age 16 or older to operate the RadRunner. You must also have the physical ability, reaction time, and mental capability to understand and obey all local laws governing ebike usage and to manage traffic, variable road conditions, and sudden situations. If you have an impairment or disability (e.g., visual impairment, hearing impairment, physical impairment, cognitive or language impairment, seizure disorder) or any other limitation that could affect your ability to safely operate a vehicle, consult your physician before operating any bike, ebike, or similar vehicle.



WARNING: This ebike is not to be operated by anyone under the age of 16. Children under the age of 16 may lack the necessary judgment and skill to safely operate the ebike, potentially resulting in damage to the ebike, damage to other property, serious injury, and/or death. Please also check your local laws, which may require a higher age. It is your responsibility to know and obey local regulations regarding rider age and other qualifications.



MINIMUM
OPERATOR AGE



DANGER: Riding any vehicle under the influence of alcohol, drugs, or any substance or condition that could impair your motor function, judgment, reaction time, or ability to safely operate a vehicle puts you at VERY HIGH RISK of serious injury or death. Operate your ebike or other vehicles only when you're sober and otherwise physically and mentally prepared to ride safely.

Know and obey all relevant local laws

The RadRunner 2 is a 250 watt (W) pedelec. Please check relevant legislation in the locations you intend to ride for a full understanding of all necessary legal requirements for operating your RadRunner 2. This manual will refer to your RadRunner 2 as the "RadRunner 2," "RadRunner," "bike," "ebike," or "electric bike." It is your responsibility to know the local laws that govern any type of vehicle you use.

Ride appropriately for conditions

Always travel at speeds appropriate for local terrain and conditions as well as your experience level. **When in doubt, slow down.**

Ride with your headlight on, which will make you more visible in any conditions. The headlight will turn on when the ebike is powered on. We recommend you keep it on whenever you ride.

Concentrate on the path ahead. Avoid potholes, gravel, ice, wet or oily roads, wet leaves, kerbs, train tracks, speed bumps, drain gates, thorns, broken glass, and other obstacles, hazards, and puncture-flat risks.



WARNING: Crossing train tracks or similar grooved or raised surfaces at a diagonal can make the surface "grab" or deflect your wheel, causing your ebike to suddenly get stuck or crash, leading to serious injury or death. Always cross such hazards at a perpendicular angle or, when in doubt, dismount and walk your ebike across.

PATH RIDING

Be a good citizen of shared-use paths and facilities. Keep your speed reasonable and below path speed limits, pass carefully and kindly. Use your voice and/or bell to signal your presence to others, especially when passing. Keep in mind that your ebike is heavy, can go at high speeds, and can hurt others if not operated with care.

ROAD RIDING

When riding on streets, obey the same road laws as all other road vehicles as well as local rules governing bike or ebike usage. Sharing the road with other vehicles presents many hazards. Always take these precautions:

- Expect the unexpected such as opening car doors or cars backing out of driveways.
- Be extra careful at intersections and when preparing to pass other vehicles or other cyclists.
- Ride predictably, in a straight line, and with the flow of traffic. **Never ride against traffic.**
- Use correct hand signals to indicate turning, and do so well in advance of turning.
- Ride defensively. To other road users you may be hard to see.
- Increase your visibility by following the tips in [“Low-visibility conditions” below](#).

OFF-ROAD RIDING

Riding off road requires close attention and specific skills, and it presents variable conditions and hazards. Don't ride off road unless you have the appropriate skills. If you choose to ride off road, wear appropriate safety gear and do not ride alone in remote areas.

LOW-VISIBILITY CONDITIONS



WARNING: Riding at night or in other low-visibility conditions (dawn, dusk, fog, rain, mist, snow, etc.) makes it harder to see and avoid hazards and makes it harder for others to see and avoid you, which increases risk of accidents, serious injury, or death. Wet, slippery surfaces will compound your risk of injury or death. Avoid these conditions whenever possible. If you must ride in these conditions, following the guidelines below can reduce risk.

- Wear reflective and brightly coloured clothing.
- Slow down.
- Use familiar routes with street lighting if possible.
- Ensure tyre wall, pedal, and other reflectors are installed and unobstructed.
- Ensure headlight and taillight/brake light are functioning correctly and unobstructed. Use them.

WET CONDITIONS

Your RadRunner is not meant for use in puddles, heavy rain, or streams. Never immerse or submerge this product in water or liquid as the electrical system may be damaged.



WARNING: Riding in wet conditions means slippery hands, feet, and riding surfaces, which greatly increases your risk of accidents, serious injury, or death. Low-visibility conditions (night, dusk, dawn, fog, mist, rain, snow, etc.) will compound your risk of injury or death. Avoid riding in such conditions. If you choose to ride in wet conditions, you do so at your own risk. Follow the recommendations below to reduce that risk.

- Decrease riding speed to help you control the ebike in slippery conditions.
- Brake earlier since it will take longer to slow down than in dry conditions.
- Take care to be more visible to others on the road, following the tips in [“Low-visibility conditions” above](#).
- Remember that road hazards are more difficult to see when wet, so proceed with extra caution.

EXTREME RIDING

There are no appropriate conditions for extreme riding. Although many articles, advertisements, and catalogues depict extreme riding, Rad Power Bikes strongly advises against such inappropriate and dangerous use of its products.



DANGER: Extreme riding puts you at **VERY HIGH RISK** of serious injury or death. Extreme riding includes but is not limited to jumps, stunts, or any riding that exceeds your capabilities or the strength and integrity limitations of certain ebike components and/or otherwise leads to dangerous situations. Never engage in extreme riding or any type of riding that exceeds your capabilities.

Wear a helmet and appropriate safety gear

We strongly advise that you and any passenger you carry wear a properly fitting, certified bicycle safety helmet while riding your ebike, which may be required by law in your area.

Wear appropriate safety gear including closed-toe shoes. If you are wearing loose pants, secure the bottom using appropriate leg clips or bands to prevent the fabric from flapping and getting caught in the chain or other moving parts. Never use items such as headphones or hoods that can compromise your hearing or field of vision. A local, professional, reputable bike shop can help advise you on what gear is best for the weather and other riding conditions in your area.

Maximize your visibility with bright colours and reflective outerwear or vests. Never compromise your ability to be seen or heard by removing your ebike's reflectors, blocking or removing the headlight or taillight, or removing the bell.



DANGER: Riding any bike, ebike, or similar vehicle without a helmet puts you at **VERY HIGH RISK** of serious head injury or death. Always wear a properly fitted helmet that covers the forehead. Many locations require specific safety devices. It is your responsibility to familiarize yourself and comply with the laws, rules, and regulations where you ride.



WEAR A HELMET

Limited warranty and other terms

Your ebike's warranty and other binding legal terms (e.g., terms of purchase, etc.) are subject to change at any time. To view your terms of purchase, go to radpowerbikes.eu/terms. To view the current warranty, please go to radpowerbikes.eu/warranty.

RAD POWER BIKES LIMITED WARRANTY TERMS

This Limited Warranty is in addition to your statutory rights.

All Rad Power Bikes ("RPB") E-Bikes (the "E-Bike") purchased in Europe, and their individual Covered Components (as defined herein), are protected against all manufacturing defects in material or workmanship with regard to the Covered Components for two years after the date of receipt of this ebike by the customer (the "Warranty Period"). This Limited Warranty is only applicable to E-Bike purchases in the UK and EU (purchases in the United States or Canada shall be subject to the applicable warranty terms offered by RPB in those jurisdictions) and in accordance with the following terms:

- Only the original owner of the E-Bike is covered by this Limited Warranty. The Warranty Period begins upon your receipt of the E-Bike and shall end immediately upon the earlier of the end of the Warranty Period or any sale or transfer of the E-Bike to another person, and under no circumstances shall the Warranty apply to any subsequent owner or other transferee of the E-Bike.
- The Limited Warranty is expressly limited to the replacement of any of the following components that come standard on your ebike model (not all parts listed come standard with all models), if those components are found to be defective: lithium ion battery (the "Battery"), frame, forks, stem, handlebar, headset, seat post, saddle, brakes, lights, bottom bracket, crank set, pedals, rims, wheel hub, freewheel, cassette, derailleur, shifter, chain tensioner, motor, throttle, twist power assist, controller, wiring harness, LCD display, LED display, UI display, remotes, kickstand, reflectors and hardware (each a "Covered Component").

THIS LIMITED WARRANTY DOES NOT COVER

- Normal wear and tear of any Covered Component.
- Consumables or normal wear and tear parts (such as tyres, tubes, brake pads, cables and housing, grips, chain, spokes), unless defective when received.
- Any damage or defects to Covered Components resulting from failure to follow instructions in the E-Bike owner's manual, acts of God, accident, misuse, neglect, abuse, commercial use, alterations, modification, improper assembly, installation of parts or accessories not originally intended or compatible with the E-Bike as sold, operator error, water damage, extreme riding, stunt riding, or improper follow-up maintenance.
- For the avoidance of doubt, RPB will not be liable and/or responsible for any damage, failure or loss caused by any unauthorized service or use of unauthorized parts.
- The Battery is not warranted from damage resulting from power surges, use of an improper charger, improper maintenance or other such misuse, normal wear or water damage.
- Damage that occurs during shipping if the owner sets up their own shipping option or if the bike is shipped using a freight forwarder or similar service.
- Any products sold by RPB that is not an E-Bike.
- Shipping damage if such damage is not reported to RPB within 30 days from receipt of product.

DETERMINING WHETHER DAMAGE OR DEFECT TO AN E-BIKE OR COVERED COMPONENT IS PROTECTED BY THIS LIMITED WARRANTY SHALL BE IN SOLE DISCRETION OF RPB.

CLAIMS PROCESS

RPB WILL NOT REPLACE ANY COVERED COMPONENT UNDER THIS LIMITED WARRANTY WITHOUT FIRST SEEING PHOTOS OR VIDEO OF THE DAMAGED COVERED COMPONENT.

Before making a warranty claim, we suggest that you contact our Product Support team at eu-support@radpowerbikes.com as there may be a simple fix for your problem.

Subject to your rights to cancel set out in the Consumer Purchase Terms and Conditions, in order to exercise your right to receive a replacement for a Covered Component under this Limited Warranty, you must:

- Contact the RPB Product Support team by email at eu-support@radpowerbikes.com or by phone at +31-85 7470430 or UK: +44 800 069 8513. The Product Support team will initially work with you on the problem with your E-Bike to identify potential simple fixes.
- In the event that the Product Support team determines that a Covered Component must be replaced, they will provide you with a set of instructions for returning the defective Covered Component and receiving the replacement.
- After you receive the replacement Covered Component, the Product Support team will also provide assistance in determining how to replace or install the new Covered Component into your E-Bike.
- You will be responsible for shipping costs associated with returning a Covered Component, unless RPB agrees in writing to pay for such shipping costs. Replacement Covered Components under this Limited Warranty shall only be shipped to the address of the original purchaser.

All claims to this warranty must be made through Rad Power Bikes within 2 years of initial purchase. Warranty claims may be submitted to eu-support@radpowerbikes.com

Warranty parts will only be shipped within the 26 countries we are currently shipping to. If you had your E-bike delivered to one country and then shipped to another country, parts will only be sent to the country in which the bike was originally delivered.

THIS LIMITED WARRANTY GIVES YOU SPECIFIC LEGAL RIGHTS AND YOU MAY ALSO HAVE OTHER STATUTORY RIGHTS IN RELATION TO THE PRODUCTS AND THOSE RIGHTS ARE NOT AFFECTED BY THIS LIMITED WARRANTY.

Watch the assembly video!

Get your latest manual!

We do our best to make this manual as clear, comprehensive, and accurate as possible, but sometimes we learn new things, catch errors, improve explanations, or add important new safety information. The manual you're reading right may not be the latest version unless you just downloaded it.

Please go to our Help Centre at radpowerbikes.eu/help to download the latest manual and to watch your assembly video so you can have the safest, most enjoyable experience with your new ebike!

Thanks for riding Rad!