



OWNER'S MANUAL UPDATES

The following information updates your ebike's Owner's Manual. Please read it carefully. Keep your owner's manual and any other documents that came with your ebike. All content in this update and the manual is subject to change or withdrawal without notice. Visit www.radpowerbikes.eu/help to view and download the latest version. Rad Power Bikes makes every effort to ensure the accuracy of its documentation and assumes no responsibility or liability if any errors or inaccuracies appear within.

 **WARNING:** Incorrect assembly, maintenance, or use of your ebike can cause component or performance failure, loss of control, serious injury, or death. Even if you're an experienced bike rider, **you must read and understand the entire manual and any documentation provided for subcomponents or accessories before riding.** If you are not sure you have the experience, skills, and tools to correctly perform all assembly steps in the manual and the assembly video at www.radpowerbikes.eu/help, consult a local, certified, reputable bike mechanic.

 **WARNING:** To reduce the risk of injury, close supervision is necessary when the product is used near children.

Guard against rust, water damage, and corrosion

Like any vehicle used outdoors, your ebike needs care to ensure it isn't damaged by the elements. Follow these steps for a long, healthy life for your ebike:

- Store under shelter and in an upright position; avoid leaving the bike in the rain or exposed to corrosive substances such as water, salt, or de-icing substances. If exposed to rain, dry your bike afterward, and apply an anti-rust treatment to the chain and other unpainted steel surfaces.
- To clean your ebike, turn the bike and battery off and wipe the frame with a clean, damp cloth. If needed, apply a mild, non-corrosive detergent mixture to the damp cloth and wipe the frame. Dry by wiping with a clean, dry cloth. Never use high-pressure water on your bike. Wipe down your bike frequently and wipe or spray all unpainted mechanical parts with anti-rust treatment.
- If painted metal parts become scratched or chipped, use touch up paint or nail polish to prevent rust.
- Never immerse or submerge the bike or any components in water or liquid, which can damage the electrical system.
- Avoid riding on the beach, in coastal areas with high-salinity fog, or on surfaces treated with salt or de-icing compounds. Doing so exposes your bike to salt or other substances that are very corrosive. Corrosion of electrical components can lead to permanent, irreversible damage that can cause battery failure, electrical system failure, or electrical fire. Damage from corrosion is not covered under warranty.

 **WARNING:** Damage to your ebike's electrical system caused in any manner, including water intrusion, can lead to battery failure, electrical system malfunction, or electrical fire and consequent property damage, injury, or death. Follow all recommendations to minimize chance of water damage. If you have any questions, contact Rad Power Bikes Product Support.

 **WARNING:** Using a damaged battery or charger can create additional bike damage or a fire hazard. Stop using your battery and charger and contact Rad Power Bikes immediately if any of the following occur: (1) Your charger's flexible power cord or output cable or any of the electrical cables on your bike is frayed, has broken insulation, or any other signs of damage, (2) Your battery or charger is physically damaged, non-functional, or performing abnormally, (3) Your battery or charger experienced a significant impact from a fall or crash, with or without obvious signs of damage, or (4) Your charger becomes too hot to touch (it's designed to get warm with normal use), makes a funny smell, or shows other signs of overheating. Store any damaged battery or charger in a safe location and, as soon as possible, recycle or otherwise dispose of it according to local rules. Contact Rad Power Bikes if you have any questions or to purchase a compatible replacement battery or charger.

How the electrical system works

This ebike is equipped with two ways for a rider to use power assistance from the motor to propel the bike forward: a pedal assist system (PAS) and a twist power assist.

HOW PEDAL ASSIST WORKS

The rider can engage the pedal assist system (PAS) while pedaling, and it will call up assistance from the motor to help propel the bike forward.

Pedal assist uses a cadence sensor built into the drivetrain of the bike. The sensor detects when the rider revolves the pedals and signals the electric motor to provide the level of pedal assistance (PAS 0-5 on most models and 0-4 on the RadRunner and RadMission) that has been selected.

HOW THE TWIST POWER ASSIST WORKS

To engage the twist power assist while pedalling, slowly and carefully rotate the twist power assist grip backwards towards yourself. When the bike is on and you are pedalling at an adequate cadence, the twist power assist function acts as an adjustable, on-demand pedal-assistance boost. It is not designed to be used when the rider is not pedalling.

Do not touch the brake rotor



WARNING: Touching the brake rotor, which has sharp edges and can get very hot while you're riding, can cause serious injury, slicing damage, or burns. The brake rotor heats up from normal friction when the brake pads press against the brake rotor to slow or stop the bike. Touching the brake rotor with bare skin can also transfer natural oils to the rotor, which can decrease braking performance. **Do not touch the brake rotor, especially when it's in motion or after you've been riding your bike.** Touch the brake rotor only for necessary maintenance when it is cool, not moving, and while you are wearing gloves or using other appropriate protective equipment.



Warranty update

Notwithstanding the warranty information in the manual, the warranty period begins at the date of receipt of this ebike by the customer. The latest version of the warranty terms is available at www.radpowerbikes.eu/terms.

RADMISSION™

OWNER'S MANUAL

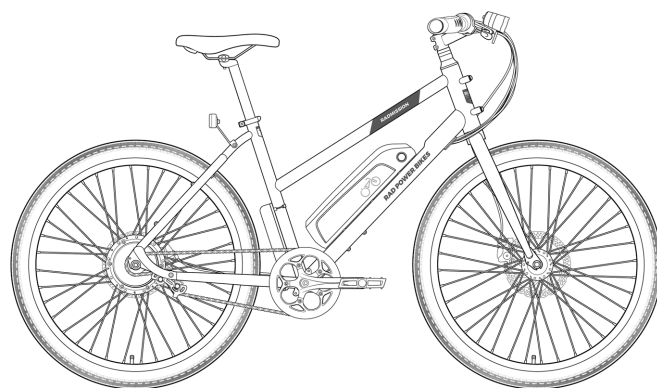
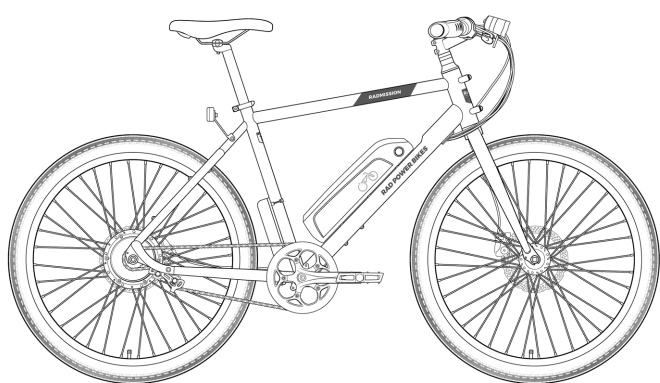

Welcome!

Thank you for purchasing the RadMission™ 1 from Rad Power® Bikes!

We take pride in bringing you a quality product that will offer years of enjoyment. Please read and understand this manual fully before assembling and riding your bike, and check out the official RadMission assembly video in the “Help Centre” section of the Rad Power Bikes website (www.radpowerbikes.eu/help).

Be sure to check all hardware for correct torque (see [“Tools and recommended torque values” on page 9](#)) during assembly. Before each ride, follow the recommendations in the [“Safety checklists” on page 18](#). Finally, take care of your new RadMission by following the guidelines in [“Recommended service intervals” on page 20](#). If you’re not sure you have the skills, experience, and special tools required for assembly and maintenance, get help from a local, certified, and reputable bike mechanic.

We are here to help!

If you have questions after reading this manual and watching the assembly video, please consult the Rad Power Bikes Help Centre, contact us by email, and/or give us a call on the phone. **Thanks for riding Rad!**

Rad Power Bikes

Help Centre: www.radpowerbikes.eu/help

Phone: +31-85 7470430

Email: eu-support@radpowerbikes.com

Contents

Using this manual	2
Assembly instructions for the RadMission	2
Adjusting for comfort and safety	7
Tools and recommended torque values	9
Battery information	9
Operation	12
Maintenance	17
Troubleshooting	23
Ride as safely as possible	25
Limited warranty and other terms	28

Using this manual

This manual contains critical details about how to safely operate and maintain your RadMission. Read it carefully and familiarize yourself with your ebike before riding it. Pay special attention to the safety messages shown here.

NOTICE: A “notice” is important information that can help you avoid bike/property damage or extend the life of parts and the bike.



CAUTION: A “caution” statement indicates a hazardous situation that, if not avoided, could result in minor or moderate injury or property damage.



WARNING: A “warning” statement indicates a hazardous situation that, if not avoided, could result in death, serious injury, or property damage.



DANGER: A “danger” statement indicates a hazardous situation that, if not avoided, has a very high risk of death, serious injury, or property damage.

Riding any bike or other vehicle always involves some risk of serious injury or death. Your safety depends on many factors including your bike knowledge, your bike’s maintenance, foreseeable riding conditions, etc. There are also factors we cannot control or anticipate in every situation or condition while riding. This manual makes no representations about the safe use of bikes under all conditions. If you have any questions you should contact Rad Power Bikes immediately.

Assembly and first adjustment of your bike from Rad Power Bikes requires special tools and skills. We recommend that you have this done by a certified, reputable bike mechanic.

Keep this manual and any other documents that came with your RadMission. All content in this manual is subject to change or withdrawal without notice. Visit www.radpowerbikes.eu/help to view and download the latest version. Rad Power Bikes makes every effort to ensure the accuracy of its documentation and assumes no responsibility or liability if any errors or inaccuracies appear within.

Assembly instructions for the RadMission

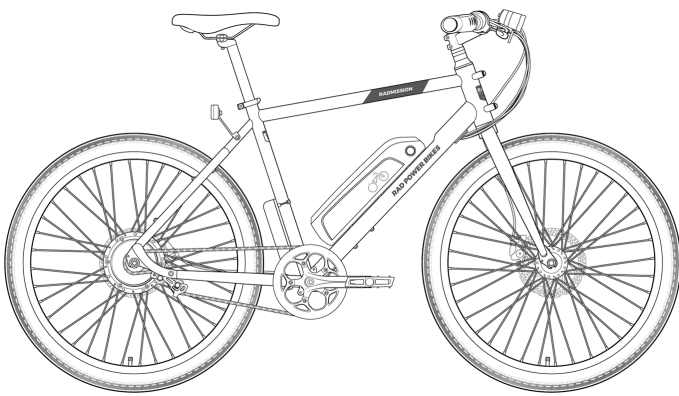

Fully assembled RadMission 1 High-Step

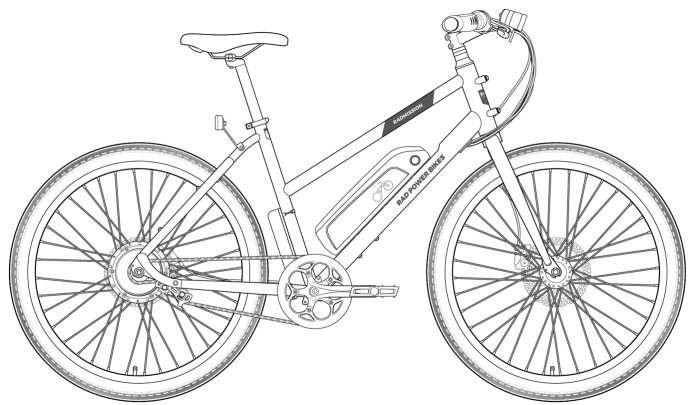

Fully assembled RadMission 1 Mid-Step

The following steps provide an overview of how to assemble your RadMission 1 from Rad Power Bikes. They are not a complete or comprehensive manual of all aspects of assembly, maintenance, and repair, which involve specialized tools and skills. We recommend you consult a certified, reputable bike mechanic to assist in the assembly, repair, and maintenance of your RadMission.

WARNING: Incorrect assembly, maintenance, or use of your RadMission can cause component or performance failure, loss of control, serious injury, or death. Even if you’re an experienced bike rider, **you must read and understand the entire manual and any documentation provided for subcomponents or accessories before riding.** If you are not sure you have the experience, skills, and tools to correctly perform all assembly steps in the manual and the assembly video at www.radpowerbikes.eu/help, consult a local, certified, reputable bike mechanic.

1. **Unpack the bike.** Open the bike box and, with the help of another person capable of safely lifting a heavy object, remove the RadMission from the bike box, placing it upright on the back wheel and front fork protector plate. Carefully remove the packaging material protecting the bike frame and components, and keep the packaging materials in case you want to ship the bike. Otherwise, recycle these materials, especially cardboard and foam, wherever possible. Remove the small box from the bottom of the bike box and carefully set out the contents. **Ensure all of the following pieces are included with the RadMission:**

- Front wheel
- Headlight and mount
- Manual
- Assembly toolkit
- Charger
- Keys (two, identical)
- Pedals (left and right)
- Handlebar stem faceplate (1x) plus bolts (4x) and washers (4x)
- Front wheel quick release (in fork protector plate)

If anything is missing, please contact Rad Power Bikes.

We also recommend the following (not included) for assembly and maintenance:

- A strong friend
- Flat-side cutters
- 15 mm pedal wrench
- Bicycle grease
- Clean shop towel or paper towel for cleaning excess grease
- Bike pump with Schrader valve and pressure gauge
- Torque wrench (3 Nm-60 Nm) with Allen bits
- 8 mm Allen wrench

2. **Position the front fork properly.** The front fork should come in the shipping box rotated so that it's facing backwards (this helps it fit in the box), as shown in the illustration. Rotate the fork so it faces forwards. When the fork is correctly positioned, the brake calliper (circled in orange) will be on the rider's left side (the non-drivetrain side of the bike, without the chain). Cables should also not be twisted around the back of the headtube.

3. **Install the handlebar and headlight onto the stem** as shown in the RadMission assembly video available at www.radpowerbikes.eu/help.

- Gather what you'll need:** The handlebar, the handlebar faceplate, the four faceplate bolts and washers (which are located in the accessory box), a 4 mm Allen wrench, and the headlight that comes mounted on its bracket.
- Position the handlebar on the stem.** Trace the front brake cable directly up from the front brake calliper to the left handlebar. Ensure the cables and wires are not twisted and that the LED display will face the rider.

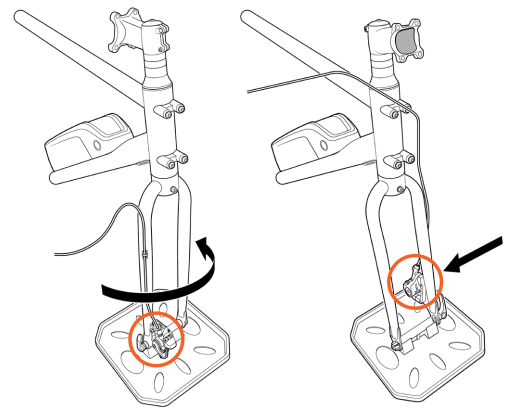

LEFT: The front fork facing backwards (incorrect). **RIGHT:** The front fork facing forwards (correct). Note the position of the brake calliper circled in orange.

Installing the handlebar and headlight

1	Allen wrench
2	Bottom faceplate bolt
3	Split washer
4	Faceplate
5	Headlight bracket mounting slots
6	Stem faceplate bottom mounting points
7	Handlebar
8	Stem (handlebar stem)

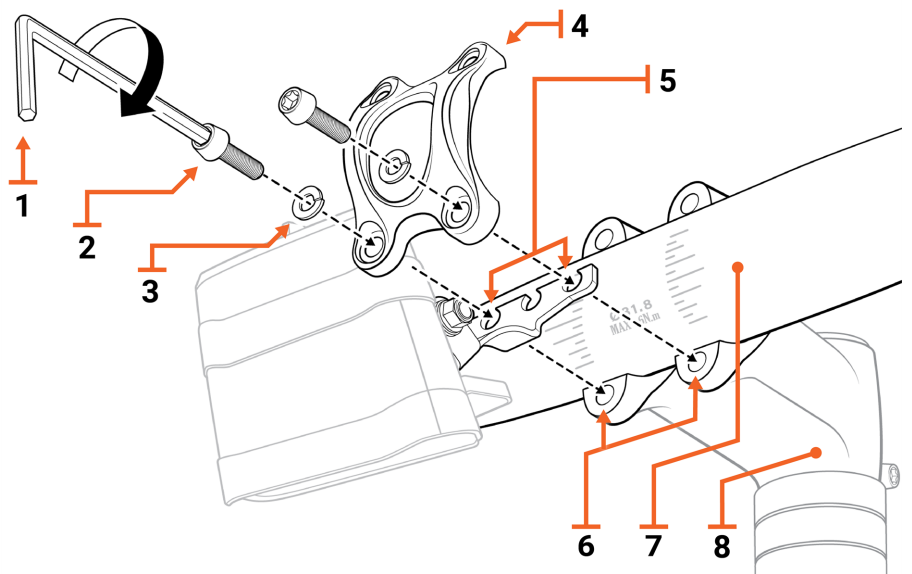

- c. **Loosely secure the handlebar and headlight bracket to the stem** using the illustration above for reference. Pass the bottom two faceplate bolts (labelled 2 in the illustration) through the following components in this order: the split washers (3), the faceplate (4), the outside slots on the headlight bracket (5), and finally into the bottom two stem mounting points (6). **Make sure the headlight bracket is between the faceplate and stem**, not in front of the faceplate. Use a 4 mm Allen wrench to turn the bottom two faceplate bolts about two full turns each—enough that they will hold the components together loosely.
- d. **Loosely secure the top of the faceplate.** Pass the remaining two faceplate bolts through the split washers, the top holes in the faceplate, and into the top stem mounting points. Turn the top two faceplate bolts into the mounts about two full turns each (enough that they will hold the components together loosely).
- e. **Fine-tune the handlebar positioning.** Make sure the handlebar is centred on the stem (the etchings on the handlebar are a helpful guide) and that the handlebar grips will be roughly parallel to the ground once the front wheel is installed.
- f. **Tighten the bolts evenly.** Tighten each bolt about a quarter of a turn, and then repeat among the bolts until all four feel secure.
- g. **Torque the faceplate bolts evenly.** Use a torque wrench with a 4 mm Allen bit to torque all faceplate bolts to 6 Nm.

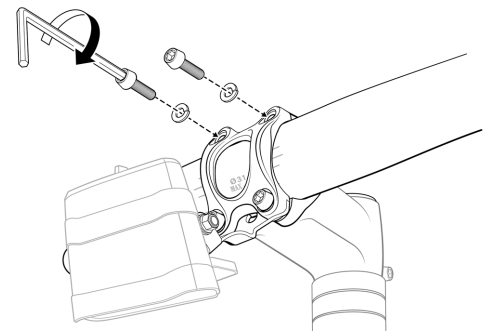

Loosely secure the top faceplate bolts.

4. Connect the headlight.

- a. **Locate the headlight connector**, the red two-pin connector on the wiring harness (the cables at the front of the bike). This should be the only unconnected cable coming out of the wiring harness junction (the molded bundle of cables on the wiring harness).
- b. **Plug in the connector.** Locate the cable coming out of the headlight. Carefully align the internal notch and pins and the external arrows of this connector with the connector you identified in the previous step, and then press them together directly **without twisting**.



The headlight cable (see orange arrow) comes down from the cable wiring junction and then bends back up.

5. Install the pedals.

- a. Locate the right-side pedal, which is marked “R,” should have an “R” sticker attached, and has a smooth pedal axle. The right pedal goes on the crank on the drivetrain side of the bike, which has the chain and is the same as a rider’s right side when seated on the bike.
- b. Carefully thread the right pedal onto the right crank by turning clockwise. Do so slowly and gently by hand. Do not cross thread or damage the threads. See the [“Right pedal installation”](#) illustration.

Right pedal installation

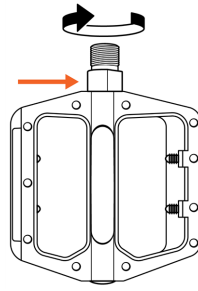

Right pedal with smooth pedal axle.

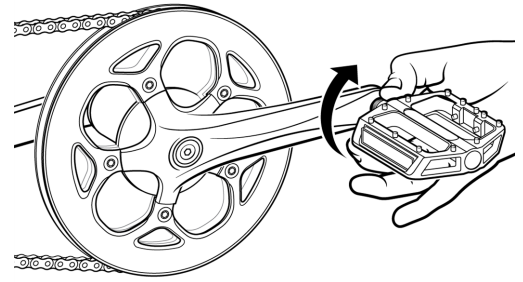

Thread the right pedal onto the right crank gently by hand, turning clockwise.

- c. Carefully thread the left pedal onto the left crank by turning anticlockwise. The reverse-threaded left pedal is marked with an “L,” should have an “L” sticker attached, and has notches on the pedal axle. Thread slowly and gently by hand without crossing thread or damaging the threads. See the [“Left pedal installation”](#) illustrations.

Left pedal installation

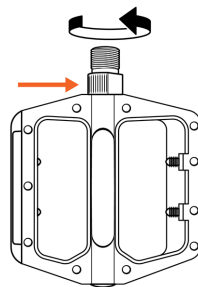

Left pedal with notches on the pedal axle.

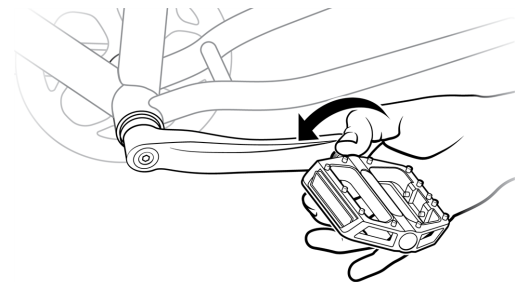

Thread the left pedal onto the left crank gently by hand, turning anticlockwise.

- d. Tighten each pedal using a pedal wrench to avoid damage caused by wider wrenches, as shown in the assembly video at www.radpowerbikes.eu/help.
- e. Torque each pedal to 35 Nm.

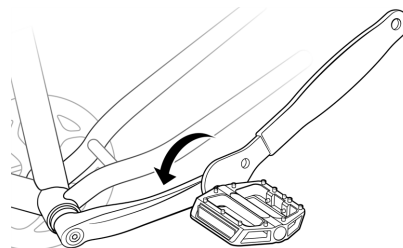

Pedal wrench on left pedal

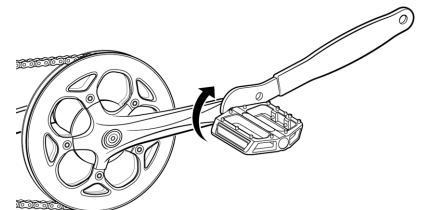

Pedal wrench on right pedal

- 6. Check the chain alignment. Stand at the right side of the bike and grab the right pedal. Rotate the right pedal and crank towards the back of the bike as though pedalling backwards—this will run the chain through the drivetrain without spinning the wheels. Watch the chain and ensure the chain runs through the drivetrain (the rear cog, chain tensioner, and around the front chainring) smoothly. If the chain doesn’t run smoothly or something seems misaligned, please contact Rad Power Bikes Product Support.

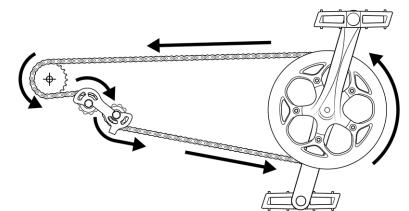

To test that the chain runs smoothly, pedal backwards.

- 7. Install the seat and seatpost. Locate the seat and seatpost and then follow these steps:

- a. Remove the seat and seatpost from the seat tube (the part of the frame that holds the seatpost): Open the quick release lever on the seat tube and gently pull the seat and seatpost out.
- b. Apply a thin layer of bike grease to the seatpost using a clean shop towel rag, and then wipe off any excess grease.

- c. **Make sure the quick-release lever on the seat tube is open** (see the first illustration at [“Installing the seat and seatpost” below](#)) and that the quick-release clamp opening is aligned with the notch in the seat tube (see the dotted lines in the illustration).
- d. **Insert the seatpost into the seat tube** as shown in the middle illustration at [“Installing the seat and seatpost” below](#). Make sure that the minimum insertion point etched onto the seatpost goes into the seat tube (it should not be visible). Secure with the quick release lever, as shown in the third illustration at [“Installing the seat and seatpost” below](#). Closing the lever should require enough pressure that it leaves an imprint in your hand. When closed, the seat should not move up, down, left, or right. If needed, adjust the lever tension by turning the adjustment nut opposite the quick release lever while the lever is open. You can fine-tune the position and angle of the seat later, according to directions in [“Adjusting for comfort and safety” on the next page](#).

Installing the seat and seatpost

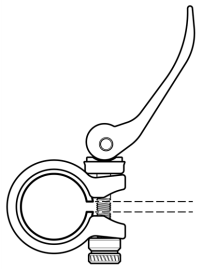

Open the quick-release lever

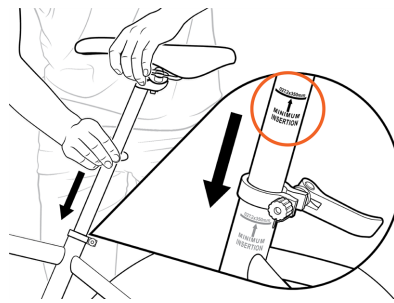

Insert the seatpost, ensuring the minimum insertion point (circled in orange) goes into the seat tube.

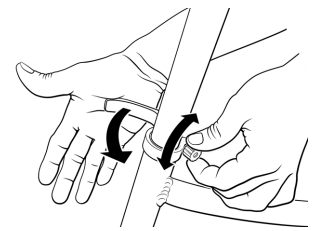

Close the quick release lever using your palm.



DANGER:

Overextending the seatpost can cause it to break or fall off your bike, which will put you at very high risk of serious injury or death. Avoid this danger by inserting your seatpost into the seat tube far enough that the minimum insertion point is no longer visible.

8. **Inflate tyres.** Check that the tyre beads and tyres are evenly seated around the rims. Use a pump with a Schrader valve and pressure gauge to inflate each tyre to the recommended pressure indicated on the tyre sidewall. Do not overinflate or underinflate tyres. For more information, see [“Tyre and wheel care” on page 21](#) or visit our Help Centre at www.radpowerbikes.eu/help.
9. **Install the front wheel** onto the front fork as shown in the assembly video at www.radpowerbikes.eu/help.
 - a. **Locate the quick release lever**, which holds the protector plate in place during shipment. Open the lever and remove the thumb nut and cone spring (opposite the lever). Remove the quick release skewer from the plate, keeping the washer and other cone spring in place on the lever side.
 - b. **Install the skewer into the front wheel hub** from the brake rotor side. Reinstall the cone spring so it points towards the wheel hub, and then thread the thumb nut onto the skewer only a couple turns, leaving room for the fork dropouts.
 - c. **Fully seat the skewer in the fork dropouts.** Make sure the lever is open and carefully lower the fork onto the axle. Check that the brake rotor is in the calliper. Add tension to the quick-release lever by turning the thumbnut. When there is enough resistance to hold the quick release lever in line with the axle, close the lever using the palm of your hand. Do not touch the brake rotor.

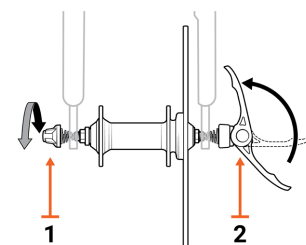

Front wheel: adjustment nut (1) and quick release lever (2)

When properly installed, the front wheel should be fully seated and centred in the dropouts of the front fork, the brake rotor should be between the brake pads in the brake calliper, and the quick release lever should be fully and properly secured. Ensure the front wheel and quick release lever are properly secured before moving on to the next step.

Note: Closing the quick release lever should require enough pressure that it leaves an imprint in your hand. If it's too easy or too difficult to close, adjust the lever tension by turning the adjustment nut (“1” in the “Front wheel” illustration) opposite the quick release lever. Check the front wheel security on a regular basis: the front wheel should

always be fully seated in the dropouts of the front fork, and the quick release lever should always be properly secured.

10. Perform a handlebar twist test to ensure the front wheel and handlebar stem are securely connected. Instructions for doing so are in [“Handlebar twist test” on page 22](#).
11. **Check the security of the rear wheel.** The rear wheel security and hardware torque should also be checked on a regular basis (see [“Tools and recommended torque values” on page 9](#)). Either wheel can become loose or unsecured with normal use.



WARNING: An improperly secured front or rear wheel can cause loss of control, accidents, serious injury, or death. Check that both wheels are properly secured during assembly and before each ride.

12. **Adjust the headlight angle.** Use a 4 mm Allen wrench and 8 mm wrench on the locknut to loosen the headlight angle adjustment bolt (see illustration). With a friend holding the bike upright, adjust the headlight angle so it will illuminate the road ahead but not blind oncoming traffic. Tighten the locknut on the adjustment bolt to hold the light in place securely. Do not overtighten.

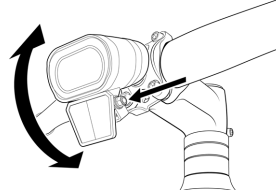

Headlight angle adjustment bolt (small arrow)

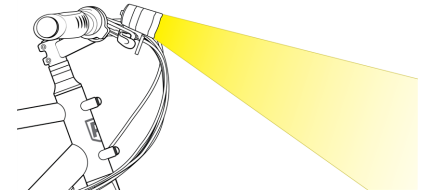

Headlight pointing slightly downwards to not blind others

13. **Complete all steps in [“Adjusting for comfort and safety” below](#)**, including checking that all hardware has been tightened according to the values in [“Tools and recommended torque values” on page 9](#).

Adjusting for comfort and safety

The following steps are critical for your comfort and safety, and **must** be performed before your first bike ride. We recommend that you consult a bike fitting professional such as a certified, reputable bike mechanic who specializes in bike fit.

Adjusting the seat angle and horizontal position

Many riders will prefer the seat to be roughly parallel to the ground, with its horizontal position in the middle of the range marked on the seat rails. To change the angle and horizontal position of the seat:

1. Use a 6 mm Allen wrench to loosen the seat adjustment bolt on the clamp positioned just below the seat. Do not remove the bolt fully.
2. Move the seat backwards or forwards and tilt to adjust the angle. Do not exceed the limit markings etched into one of the seat rails, which show how far you can safely move the seat forwards and backwards.
3. Ensure the top of the seat rail clamp is aligned directly over the bottom of the clamp so that the seat adjustment bolt will clamp the seat rails properly. Then, while holding the seat in the desired position, use a 6 mm Allen wrench to tighten the seat adjustment bolt securely to the recommended torque value, 15 Nm.

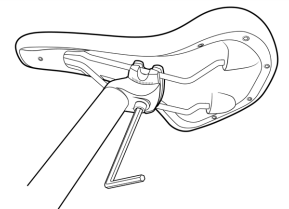

Seat adjustment bolt with Allen wrench



WARNING: A loose seat clamp or seatpost adjustment bolt can cause loss of control, bike/property damage, serious injury, or death. Prior to first use, be sure to tighten the seat clamp via the seat adjustment bolt properly. Regularly check to make sure that the seat adjustment bolt is properly tightened and the clamp is secure on the seat rails.

Adjusting the seat height

An ideal seat height for most riders allows them to be comfortable and get the best pedalling efficiency. When the rider is seated, they should be able to place the ball of their foot on the pedal at its lowest position while their leg is almost fully extended, with the knee slightly bent. The seat should never be so high that the rider must rock side to side or fully straighten their legs while pedalling. And the seat must never be pulled out so far that the minimum insertion point is above the seat tube (see illustration).

Depending on a rider's preference, ability, and amount of experience with bike and ebike riding, lowering the seat so the rider can put one or both feet on the ground without dismounting from the seat may offer a safer and more comfortable experience while operating the bike.



Seatpost out TOO FAR
The minimum insertion point on the seatpost must be inserted into the seat tube.

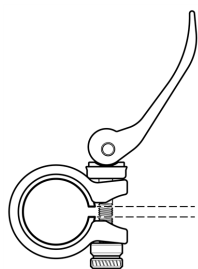

Open the quick-release lever

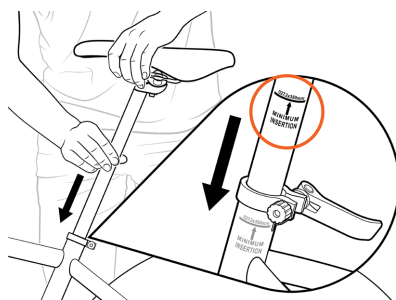

Insert the seatpost, ensuring the minimum insertion point (circled in orange) goes into the seat tube.

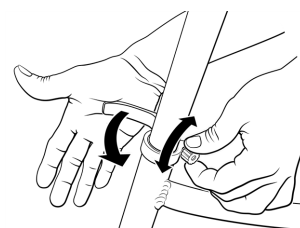

Close the quick release lever using your palm.

1. **Open the seatpost quick-release lever.**
2. **Slide the seatpost in or out of the seat tube** to a height appropriate for your leg length and preference. *Do not extend the seatpost beyond the minimum insertion marking etched onto the seatpost* (see the [“Seatpost out TOO FAR”](#) illustration).
3. **Align and close the quick release lever fully.** The quick release clamp opening should align with the notch in the seat tube. Closing the lever should require enough pressure that it leaves an imprint in your hand. When closed, the seat should not move up, down, left, or right. If needed, adjust the lever tension by turning the adjustment nut opposite the quick release lever.
4. **Try out your seat fit,** and repeat steps 1–3 if the seat position needs a bit more adjusting.

Fine-tune the handlebar and brake lever positioning

Most riders, especially those who are average height or taller, will be comfortable with the handlebar angled so that the handlebar grips are roughly parallel with the ground. Others may have a preference for the handlebar grips to be angled slightly downwards.

The angle of the brake levers can also be adjusted for the most comfortable hand position possible. To do so, loosen the brake lever clamp bolt, adjust the angle, and then re-tighten according to the torque specifications in [“Tools and recommended torque values” on the next page](#).

However you prefer your handlebar and brake levers, make sure that you can twist your handlebar 90° left and right without the handlebar or brake levers touching your body or the frame of the bike. Ensure there is enough cable slack to allow the handlebar to turn fully to each side without pulling cables taut.

If you adjust your handlebar or brake levers, be sure to tighten them according to the specifications in [“Tools and recommended torque values” on the next page](#). You can find more information about bike fit and making adjustments to your bike in our Help Centre at www.radpowerbikes.eu/help.

Ensure all hardware is tightened properly

Ensure all hardware is tightened properly according to the values in [“Tools and recommended torque values” on the next page](#). This is a critical safety step that you must not skip. If you do not own a torque wrench or don't have the skills to check the tightness of your hardware, consult a local, certified, reputable bike mechanic for help.

Tools and recommended torque values

The tool sizing listed below is a general guide, but it is possible that the head of a particular bolt on your bike may vary, requiring a different tool (e.g., a 4 mm Allen wrench instead of a 5 mm Allen wrench). If so, use whatever tool fits the bolt head. Such differences will not affect the recommended torque for that piece of hardware.

		Tool	Rec. torque
Handlebar area	Stem clamp bolts	4 mm Allen	10 Nm
	Stem faceplate bolts	4 mm Allen	6 Nm
	Headlight angle adjustment bolt	4 mm Allen, 8 mm wrench	tighten securely; do not overtighten
	Brake lever clamp bolts	5 mm Allen	6 Nm
	Twist power assist clamp bolt	3 mm Allen	3 Nm
Brake area	Calliper adapter to frame	5 mm Allen	6-8 Nm
	Calliper to adapter	5 mm Allen	6-8 Nm
	Cable pinch bolt on calliper arm	5 mm Allen	6-8 Nm
	Brake rotor to hub	T-25 Torx bit	7 Nm
Seat area	Seat adjustment bolt	6 mm Allen	15 Nm
Rear dropout area	Rear axle nut	18 mm wrench	40 Nm
	Torque arm bolt	4 mm Allen	5 Nm
	Chain tensioner mounting bolt	4 mm Allen	6 Nm
Bottom bracket and crank area	Pedal into crank arm	15 mm pedal wrench	35 Nm
	Crank arm removal info	CCP-22 Park Tool	n/a
	Crank arm bolt into bottom bracket spindle	8 mm Allen	35 Nm
	Chainring bolts	5 mm Allen	10 Nm
	Controller mounting bolts	Phillips head	6 Nm
	Bottom bracket and cups	BBT-22 Park Tool	60 Nm

If you are installing accessories from Rad Power Bikes on your RadMission, any necessary instructions, important safety information, and torque specifications will come with your accessory and/or be available online at www.radpowerbikes.eu/help.

Battery information

The battery that comes with your RadMission is a state-of-the-art, lithium-ion battery that's designed to give you years of power with proper care and use. Follow the recommendations here for the best possible performance.

 **WARNING:** Charging your battery with a charger other than one supplied by Rad Power Bikes and designed for your specific bike serial number can cause damage to your bike's electrical system or create a fire hazard. Only use a battery charger designed for your bike and supplied by Rad Power Bikes.

- The battery should be fully recharged after each use. That way, you'll get the maximum range on your next ride and reduce the chance that you'll over-discharge the battery, which can reduce its lifespan. There is no memory effect on this type of battery, so charging after short rides will not cause damage.
- Charging the battery after a ride generally takes 3 to 5 hours (see "[Estimated charging time](#)" on page 12) unless you're

performing battery balancing (see [“Balancing the battery” on the next page](#)). In rare cases, charging may take longer to allow the battery management system to balance the battery, particularly when the bike is new, after long periods of storage, or if the battery has been completely depleted.

- Do NOT operate the bike with the key in the keyport, or injury to your leg or damage to the electrical system can occur.

NOTICE: Failure to follow the battery-charging best practices outlined here and in the following sections could result in unnecessary wear to the charging components, battery, and/or charger, and could lead to an underperforming or non-functional battery. Batteries damaged due to improper care will not be replaced under warranty.

 **WARNING:** Using a damaged battery or charger can create additional bike damage or a fire hazard. Stop using your battery and charger and contact Rad Power Bikes immediately if any of the following occur: (1) Your battery or charger is physically damaged, non-functional, or performing abnormally, (2) Your battery or charger experienced a significant impact from a fall or crash, with or without obvious signs of damage, or (3) Your charger becomes too hot to touch (it's designed to get warm with normal use), makes a funny smell, or shows other signs of overheating. Store the damaged battery in a safe location and, as soon as possible, recycle or otherwise dispose of it according to local rules. Contact Rad Power Bikes if you have any questions or to purchase a compatible replacement battery.

 **DANGER:** Never open the battery housing, which will void the warranty and can result in battery damage. It can also expose you to caustic substances and electrical shock or it could create a fire hazard, which can lead to serious injury or death.

Removing and installing the battery

You can charge your battery either when it's on or off your bike. If you choose to remove it for charging, storage, transportation, security, or some other reason, keep the following tips in mind to prevent battery damage.

BATTERY REMOVAL

- To remove the battery, turn its key to the off and unlocked position (see [“Start-up procedure” on page 14](#)) and remove the key from the keyport. Carefully pull the battery forwards and up until the battery detaches from the battery mount.
- Be careful not to drop or damage the battery when loose from the bike.

NOTICE: When the battery is off its mount, protect the battery connector terminals from damage and be sure not to touch the “+” and “-” terminal contacts. If terminals are damaged, please discontinue use and contact Rad Power Bikes Product Support immediately.

BATTERY INSTALLATION/MOUNTING

- To install the battery, make sure the key port is in the off/unlocked position and the key is removed.
- Do not force the battery into the battery mount; carefully align and slowly slide the battery down until it's in place.
- Ensure the battery is properly secured to the bike before each ride by locking the battery (see [“Start-up procedure” on page 14](#)) and then carefully pulling up on it with both hands to test the security of the battery's attachment to its mount.

Before you charge

Any time you charge your battery, whether you're following the instructions in [“Balancing the battery” on the next page](#) or [“Routine charging procedure” on the next page](#) make sure you first check the battery, charger, and electrical cables for signs of damage, and follow the guidelines below.

CHARGE IN A SAFE, APPROPRIATE LOCATION

Store and use the charger in a safe place—away from children, direct sunlight, dirt, debris, tripping hazards (including electrical cords), or any materials that could ignite in the unlikely event of a charger or battery malfunction. Position the charger and battery where they're not at risk for falls or other impacts.

 **WARNING:** Letting the charger's plug contact metal objects could cause a power discharge (a spark), which could injure you or create a fire hazard.

 **WARNING:** Letting a battery charge unattended increases the risk that a charging problem will go undetected and lead to component damage or a fire hazard. Always charge your battery where you can monitor it.

Your battery needs to charge at room temperature or a bit cooler (10° C–25° C (50° F–77° F)). It generates heat while charging, but it's designed to air-cool; keep it uncovered and the lights facing upwards on a flat, stable, hard surface.

NOTICE: Charging your battery in excessively hot or cold conditions or interfering with its ability to air-cool can damage your battery or charger. Always charge your battery in temperatures between 10° C–25° C (50° F–77° F), keep the battery and charger uncovered, make sure the charger is on a hard, flat, stable surface, and use the charger right-side-up (with charging lights facing upwards).

Balancing the battery

After each of your first three rides, follow the special charging procedure outlined below, which will ensure the cells that power the battery are balanced. After the third balance charge and your fourth ride, begin routine charging procedures as described in [“Routine charging procedure” below](#).

Note: Your battery should arrive with between 50% and 75% of a charge, so it’s ready for a first ride (see [“Start-up procedure” on page 14](#)).

1. **Begin this and every charging procedure** by following the advice in [“Before you charge” on the previous page](#).
2. **Charge your battery for as close as possible to 12 hours (but not longer)**, regardless of how far you travelled. This might require leaving the charger attached to the battery and outlet even after one of the charger’s red lights turns green (during routine charging, this green light will be your indicator that charging is complete—see [“Routine charging procedure” below](#) for more information).
3. **Disconnect the charger first from the outlet, and then from the battery.** Store the bike until you’re ready to ride.
4. **Ride the bike again** with power assistance as normal, discharging part (or all) of the battery capacity.

Repeat battery balancing steps only after a period of long-term battery storage (see [“Long-term battery storage” on the next page](#)), if experiencing noticeable range decline, if instructed to do so by Rad Power Bikes Product Support, or up to once per month with frequent use as explained in [“Recommended service intervals” on page 20](#). Do not perform battery balancing more than once per month. For routine charging, follow the steps in [“Routine charging procedure” below](#).

Routine charging procedure

When you first get your bike, follow the special charging instructions in [“Balancing the battery” above](#). For routine charging, mind the advice in [“Before you charge” on the previous page](#) and then follow these steps.

1. **Ensure the battery is off.** Align the keyport with the appropriate off position by inserting the key into the keyport and rotating to align the key with one of the off icons:

For charging with the battery on the bike, align the keyport with the "off, locked" icon (position B in the illustration).

To remove the battery for charging, align the keyport with the "off, unlocked" icon (position C in the illustration), remove the key, and remove the battery.

2. **Open the rubber cover on the charging port** on the opposite side of the battery from the keyport (see [“Charging port with rubber cover in place”](#)). Note that the keyport does *not* have a cover.

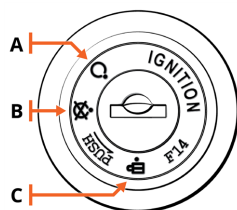

Keyport & key positions

	Description
A	On, locked to frame
B	Off, locked to frame
C	Off, unlocked from frame (for battery installation and removal)

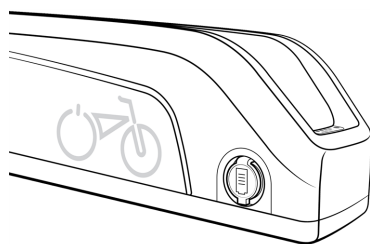

Charging port with rubber cover in place

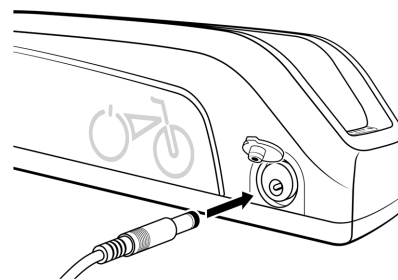

Charging port, cover open, with charger output plug positioned for insertion

3. **Plug the charger into the battery’s charging port.** With the battery installed onto or uninstalled from the bike, place the charger on a flat, secure surface with the charging indicator lights facing up, and connect the DC output plug from the charger (round barrel connector) to the charging port on the side of the battery.
4. **Plug the charger into a power outlet.** Connect the charger input plug (110/220-volt plug) to the power outlet. Charging should initiate and will be indicated by both LED charge status lights on the charger turning red. When charging is complete, one indicator light will turn green and the other will remain red.

5. **Unplug the charger from the outlet, then the charging port.** Once fully charged, indicated by one charging indicator light turning green (and one remaining red), unplug the charger from the wall outlet first and then remove the charger output plug from the battery charging port. Be sure to pull gently on the plugs, not on the cables themselves.

NOTICE: The charger is designed to stop charging automatically when the battery is full. Nevertheless, leaving your battery charging longer than necessary can cause needless wear. We recommend you remove the charger from the battery within one hour of the green light indicating a complete charge. Store the charger carefully, making sure its plug does not come in contact with liquids, dirt, debris, or metal objects, which can damage the plug and interfere with future operation.

 **WARNING:** Charging your battery with a charger other than one supplied by Rad Power Bikes and designed for your specific bike serial number can cause damage to your bike's electrical system or create a fire hazard. Only use a battery charger designed for your bike and supplied by Rad Power Bikes.

Estimated charging time

The time the charger takes to fully charge the battery depends on distance travelled, riding characteristics, terrain, payload, battery age, and other factors. The table provides a rough estimate of charge time based on common distances travelled in regular operation.

NOTICE: The battery may take longer to charge when fully depleted, when very new, and after 3–5 years of regular use. If your battery doesn't seem to be charging normally, is taking longer to charge than expected, or you're experiencing substantial reduction in range, discontinue use and contact Rad Power Bikes.

Distance	Recharge time
8 km (5 mi)	0.75 hour
16 km (10 mi)	1.25 hours
24 km (15 mi)	2 hours
32 km (20 mi)	2.75 hours
40 km (25 mi)	3.5 hours
48 km (30 mi)	4.25 hours
72 km (45 mi)	5.25 hours

Long-term battery storage

If storing your bike from Rad Power Bikes for longer than two weeks at a time, follow the recommendations below to maintain the health and longevity of your battery.

- Charge (or discharge) the battery to approximately 75% charged.
- Power off the battery either locked to the frame or unlocked and removed from the frame for storage (see [“Start-up procedure” on page 14](#) for key-position details).
- Store the battery in a dry, climate controlled, indoor location between 10° C–25° C (50° F–77° F).
- Check the battery monthly, and if necessary, use the charger from Rad Power Bikes to charge the battery to 75% charged.

NOTICE: Incorrect storage of your battery can result in a damaged or non-functional battery. Follow the above instructions to reduce such risk. Batteries damaged by improper use, charging, or storage will not be replaced under warranty.

Operation

 **WARNING:** Incorrect assembly, maintenance, or use of your RadMission can cause component or performance failure, loss of control, serious injury, or death. Even if you're an experienced bike rider, **you must read and understand the entire manual and any documentation provided for subcomponents or accessories before riding.** If you are not sure you have the experience, skills, and tools to correctly perform all assembly steps in the manual and the assembly video at www.radpowerbikes.eu/help, consult a local, certified, reputable bike mechanic.

Battery key positions

Familiarize yourself with the keyport and key positions before riding the bike. **Always remove the key before getting on your bike to ride it.**

- Any time the battery is in key position A, (on, locked to the frame) the display remote MODE button will turn the bike on and off, and the battery cannot be removed.
- If the battery is in key position B, (off, locked to the frame) no buttons or controls can be activated, the bike will remain off, and the battery cannot be removed.
- Any time the battery is in key position C, (off, unlocked from the frame) the battery must be removed from the bike before moving or riding the bike. Ensure the key is removed before sliding the battery out of the mount.

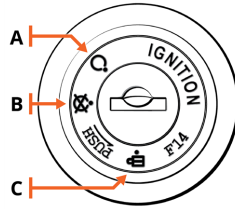

Keyport & key positions

	Description
A	On, locked to frame
B	Off, locked to frame
C	Off, unlocked from frame (for battery installation and removal)

CAUTION: An unlocked battery can fall off a moving bike, causing damage or injury. Always check that the battery is locked to the frame before moving or riding your bike.

Handlebar features

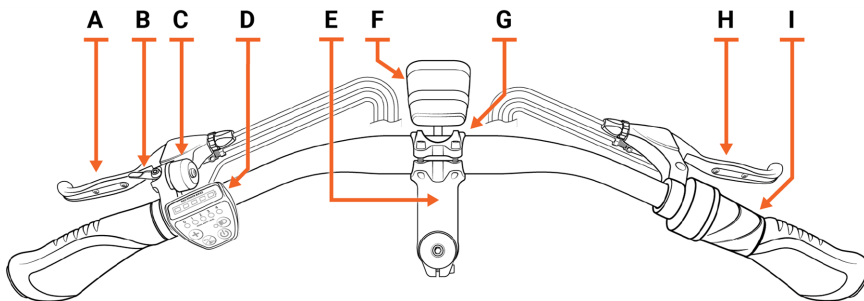

A	Left brake lever (for front brake)
B	Lever for bell
C	Bell
D	LED display
E	Stem
F	Headlight
G	Faceplate
H	Right brake lever (for rear brake)
I	Twist power assist

Electrical controls & operation

Using the LED display, you can power your bike on or off and control other electrical functions.

LED display

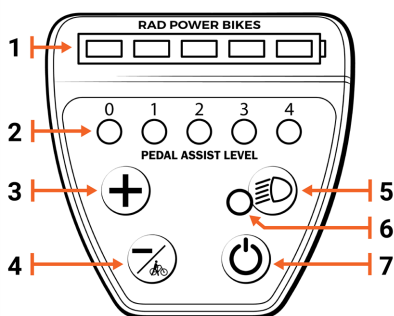

1	Battery level indicator lights	Illuminate when bike is on.
2	Pedal assist level / Error indicator lights	illuminate when bike is on. For error code info, see "Troubleshooting" on page 23.
3	Increase pedal assist (PAS) level	Press and release to increase PAS by one level.
4	Decrease pedal assist level / Walk mode	Press and release to decrease PAS by one level. Walk mode: While dismounted, press and hold to engage walk mode.*
5	Light button	Press and release to turn headlight/taillight on/off.
6	Headlight & taillight "on" indicator	Illuminates when lights are on.
7	Power button	Press and release to turn bike on/off.

* For more information on walk mode, please visit our Help Centre at www.radpowerbikes.eu/help.

CAUTION: Using walk mode inappropriately can cause you to lose control of the bike, causing bike damage or injury. Use walk mode only while dismounted from the bike, with both hands on the handlebar, and with at least one hand on a brake lever so that you can quickly cut off power to the motor if necessary.

Start-up procedure

After the bike has been properly assembled according to the assembly video, all components are secured correctly, a certified, reputable mechanic has checked the assembly, and you have read this entire manual, turn on the bike and select a pedal assist level following the steps below:

1. **Familiarize yourself with the key positions.** The [“Keyport & key positions”](#) illustration shows the keyport in position A, in line with the small open circle icon. In key position A, the battery is on and locked to the frame, ready for a ride.

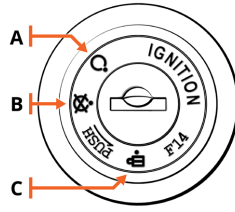

Keyport & key positions

	Description
A	On, locked to frame
B	Off, locked to frame
C	Off, unlocked from frame (for battery installation and removal)

2. **Check that the battery is locked securely.** Ensure the keyport is aligned with the circle containing an “X,” in the “Off, locked” position (B) indicating the battery is off and locked to the battery mount. If needed, insert the key and align with the “Off, locked” icon (B). Remove the key and carefully use both hands to pull up on the battery to test that the lock is secure.
3. **Turn on the bike.** With the battery locked in place, insert the key and turn clockwise to the open circle icon, which is the “On, locked” position (A), as shown in the image above. Remove the key by pulling directly backwards without twisting so the key position remains in the “On, locked” position. Locate the LED display (near the left handlebar grip). Hold down the power button for approximately 2 seconds until power is delivered to the LED display and the headlights turn on.



CAUTION: Getting onto the bike or riding it with the key left in the battery can cause injury to your leg and damage to the key or battery. Always remove the key before riding the bike.

4. **Try out your bell** if you haven't already! It's an important safety tool for alerting others to your presence, especially when passing. The bell is integrated into the left brake lever on your handlebar. To ring it, flick the bell lever, which should be near your left index finger when you're holding the handlebar; see the illustration [“Handlebar features” on the previous page](#).
5. **Select your desired level of pedal assistance (PAS)** between 0 through 4 using the up and down arrows on the LED display. Level 0 provides no pedal assistance, level 1 provides the lowest amount of pedal assistance, and level 4 provides the highest amount. Start in PAS level 0 or 1 and adjust from there.



WARNING: Engaging the pedal assist feature, especially at a high setting, will cause acceleration that may be greater than expected, especially for relatively new riders, and that can cause loss of control, serious injury, or death. To minimize risk, start at PAS level 0 or 1.

6. **Begin riding carefully.** With the proper safety gear and rider knowledge, you may now operate your bike from Rad Power Bikes. Begin by pedalling the bike with pedal assist level 0 or 1. You may also use the twist power assist to accelerate and maintain your desired speed.
7. **Use the twist power assist** (next to the right handlebar grip) by slowly and carefully rotating it towards the rider. Do not use the twist power assist unless you're on the bike, and note that the twist power assist can be activated with a twist any time the bike is powered on.

Brake light features and operation

The RadMission is equipped with a taillight/brake light that is integrated into the electrical system. Any time the bike is powered on, depressing one or both brake levers on the handlebar will activate the brake light.

The taillight also has a “flash mode” you can activate. To do so, power on the bike, and then, while dismounted from the bike, press the rubber flash-mode button on the bottom left side of the taillight housing. When in flash mode, the taillight will flash continuously, and depressing the brake lever(s) will illuminate a brighter, solid brake light. Flash mode will continue if the headlight is turned off. But if you turn the bike off and back on, you’ll need to re-activate flash mode. Please note that flashing lights may not be legal in some areas. It is your responsibility to know and obey all applicable laws where you ride your ebike.

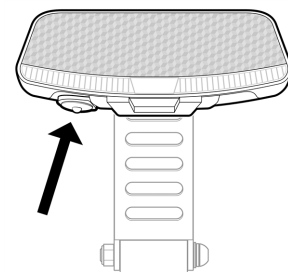

The flash mode button is on the bottom left of the taillight housing.

Battery capacity display

The display on the handlebar of your RadMission features a battery capacity gauge (like a fuel gauge on a car). This gauge calculates the remaining battery charge based on the current battery power output (instantaneous voltage reading), and can fluctuate while riding as power demand and/or output changes.

Once one bar is left on the display, users should charge the battery as soon as possible. At lower states of charge, the bike may limit power output to make the remaining power last a little bit longer, which also reduces wear on the battery. When the battery is fully depleted, the last bar will begin to flash, alerting the user that they’re about to lose all electrical power. Any time your power is off or depleted, you can still propel your bike by pedalling it.



Driving range

We suggest that you select a lower pedal assistance level when you’re getting to know your RadMission and travel routes. Once you become familiar with your range requirements and the capabilities of your bike, you can adjust your riding characteristics if you desire.

The table in this section provides range estimates under example conditions to help owners understand the factors that can increase or decrease range. Rad Power Bikes makes no claims about the range that individual users might experience in a particular situation.

40 km (25 mi):	<ul style="list-style-type: none"> • Hilly terrain • Windy 	<ul style="list-style-type: none"> • Light pedalling • Heavy payload 	<ul style="list-style-type: none"> • High pedal assist level, high twist power assist use
52 km (32 mi):	<ul style="list-style-type: none"> • Flat terrain • Not windy 	<ul style="list-style-type: none"> • Light pedalling • Normal payload 	<ul style="list-style-type: none"> • Low pedal assist level, minimal twist power assist use
88 km (55 mi):	<ul style="list-style-type: none"> • Flat terrain • Not windy 	<ul style="list-style-type: none"> • Moderate to heavy pedalling • Normal payload 	<ul style="list-style-type: none"> • Low pedal assist level, minimal twist power assist use

Best practices for extending range and battery life

Follow the best practices listed below to help extend your range and battery life.

- Whenever possible, avoid applying full twist power assist when the bike has slowed to very low speeds, has stalled, or stopped.
- Reduce your power consumption whenever possible.
- Do not climb hills steeper than 15% in grade.
- Avoid sudden starts and stops.
- Accelerate slowly.

Carrying loads

The total maximum weight limit (payload capacity) of the RadMission, listed below, includes the weight of the rider as well as clothing, riding gear, cargo, accessories, etc. The optional kickstand is not designed to be used for loading cargo. Always hold onto the bike when cargo is being loaded or in place.

Total maximum payload of the RadMission: 125 kg (275 lb)

The maximum payload capacity of specific accessories (racks, etc.) and other important safety information will come with the accessories and/or be available online at www.radpowerbikes.eu/help.

 **DANGER:** Only one person—the rider—should be on the RadMission at a time. Transporting a passenger (any person in addition to the rider) on the RadMission can result in serious injury or death to either or both the rider and the passenger. The RadMission is not designed for carrying passengers, and its optional rear rack is not compatible with Thule Yepp child carriers.

 **WARNING:** Never exceed the payload limit of any accessory or component of your bike even if you attach to it an accessory that carries a higher weight limit. Overloading any component can cause component failure, loss of control, serious injury, or death.

 **WARNING:** Loading cargo without holding onto the RadMission can cause the bike to tip, leading to damage or serious injury. The optional kickstand is designed to hold up an unoccupied, unloaded bike on a hard, flat, stable surface, not to support the weight of a rider or cargo. Always hold onto the bike when loading or unloading cargo.

 **WARNING:** Failure to ensure that cargo can't interfere with the rider's control of the bike can lead to serious injury or death. The rider is always responsible for securing loads, loose straps, and other items.

Carrying cargo

 **WARNING:** Carrying cargo significantly affects braking, acceleration, turning, and balancing, which can increase the risk of falls and other accidents, potentially leading to property damage, serious injury, or death. To minimize such risk, practise riding in a flat, open area with light cargo before attempting to carry heavier cargo, especially on roads or hills and in wet conditions.

The following list provides important tips for the safe operation of the RadMission when used for carrying cargo.

- Cargo should be loaded as low as possible to keep the bike's centre of gravity low and improve stability, but cargo should not interfere with any moving components or the ground.
- Ensure cargo loads are properly secured and periodically check that nothing loosens, risks interfering with any moving parts, or risk touching or dragging on the ground.
- Your hill-climbing ability, steering, and braking will be affected when cargo is loaded onto your bike, so plan your routes accordingly. Hills that are normally easy to climb or descend without cargo can become challenging or even dangerous once cargo is loaded onto the bike. With the extra weight, it's even more important than ever to use both front and rear brakes, and **always engage the rear brake first** to prevent excessive strain on the front wheel and fork and to prevent loss of control.

Carrying pets

Rad Power Bikes understands that you may want to bring your pet along on your bike adventures, and we urge you to take great care to protect your furry friend and yourself. We cannot recommend any pet carrier or restraint system that we have not tested for compatibility and safety with your bike from Rad Power Bikes.

 **WARNING:** Transporting a pet using any bike puts you and your pet at risk of injury or death, especially if the pet distracts you, affects your balance, interferes with moving bike parts, etc. It's impossible to anticipate every situation that can occur while riding with a pet. If you carry a pet on any bike, you assume any and all inherent risks.

Parking, storage, and transport

Please follow these tips to ensure your bike is well cared for when you're not using it.

PARKING AND STORAGE

- Park in accordance with local rules and regulations if you're in a public place.
- Park indoors whenever possible. If you must park outdoors in rain or wet conditions, do not do so for an extended period of time, and afterwards park in a dry location to allow the bike systems to dry out. When any bike is exposed to wet conditions, it will need a more frequent maintenance schedule to prevent rust and corrosion and to ensure all systems work safely. See [“Guard against rust, corrosion, and electrical damage” on page 23](#) for more information.
- Avoid parking or storing your bike in direct sunlight and/or excessive heat, such as inside of a parked car on a hot day.
- Switch the power and any lights off to conserve battery power. Remove the key from the bike and ensure the battery is locked to the frame in the off position or use the key to remove the battery and bring it with you for security.
- Lock up your bike to reduce risk of theft. You can purchase a lock from our website at www.radpowerbikes.eu or consult a local, certified, and reputable bike shop, which is also a good source for recommendations on regional bike registries. Registering your bike can increase the odds of getting it back in the unfortunate event it's stolen.

TRANSPORTING

- When pushing or carrying the bike, turn off the power to avoid accidental acceleration from the motor, e.g. by mistakenly twisting the twist power assist. Another option is to keep the bike powered on and use “walk mode”—see [“Electrical controls & operation” on page 13](#) for more information.
- Only use racks (i.e., a bike rack for your car or other vehicle) designed for the size and weight of your ebike. Pay particular attention to whether the rack can accommodate the width of your ebike tyres.
- When carrying your ebike on a rack for transport, remove the battery, and place/wrap it securely inside your vehicle, making sure it can't roll around and that its plugs and connectors are protected. This will reduce the weight of the bike, make lifting and loading it easier, and keep your battery safer.
- Do not leave a battery in direct sunlight or any location that is or may become excessively hot or cold, like a parked car, for extended periods.
- Before using public transportation—buses, trains, etc.—to transport your ebike, check with the relevant transportation authority for any rules governing weight limits, tyre widths, lithium-ion batteries, or any other rules that might pertain to ebikes.
- Avoid transporting bike(s) from Rad Power Bikes on a vehicle rack during rain, which may cause water damage to the electrical components. Contact Rad Power Bikes Product Support if you have questions.

Maintenance

To ensure safe riding conditions you must properly maintain your bike from Rad Power Bikes. Follow these basic guidelines to ensure your bike is safe and fun to ride.

Check and service your bike regularly

On any bike, certain parts need to be replaced periodically due to wear, and sometimes parts become damaged for various reasons. Check your bike before each ride by following the directions in [“Safety checklists” on the next page](#). Have your bike regularly serviced by a certified, reputable bike mechanic. See [“Recommended service intervals” on page 20](#) for more information.

Components of the RadMission are subject to higher wear when compared to bikes without power assistance. This is because the RadMission can travel at higher average speeds than regular bicycles and has a greater weight. Higher wear is not a defect in the product and is not subject to warranty. Typical components affected are the tires, brake pads and rotors, suspension forks, spokes, wheels, and the battery.

If you need to replace a part on your bike, visit www.radpowerbikes.eu. If you want something that isn't listed there, contact Rad Power Bikes Product Support. Be extremely careful about using parts or accessories that Rad Power Bikes has not tested for safety and compatibility with your specific bike model.

 **WARNING:** Using aftermarket accessories or components (trailers, stands, vehicle racks, etc.) that have not been tested by Rad Power Bikes for safety and compatibility with your specific bike may void your warranty, create an unsafe riding condition, result in bike/property damage, or cause serious injury or death. If you use replacement parts or accessories not tested and recommended by Rad Power Bikes, you do so at your own risk.

Safety checklists

BEFORE YOUR FIRST RIDE

- Make sure handlebar cables were routed correctly when the handlebar was installed. Turn the handlebar fully to the left and right and make sure this doesn't pull any of the cables or wires taut.
- Make sure your pedals are secure using a pedal wrench. Torque to 35 Nm.
- Check that the cable connectors on the bike are all plugged in securely and that nothing loosened in shipping.
- Check the brake functions per the directions in ["Tyre and wheel care" on page 21](#), but note that brakes can rub a little the first few times you ride. This is okay and normal; any squeak or noise should go away with use.
- Check everything on the "Before every ride" list below.

BEFORE EVERY RIDE

Before every ride or every 40–72 km (25–45 miles), follow the safety checklist in the table below. If you find anything amiss with your bike, don't ride it until you're sure it's fixed. Consult a local, certified, and reputable bike mechanic or call Rad Power Bikes Product Support if you have any questions.

Fasteners

- Ensure all fasteners are correctly tightened according to the specifications in ["Tools and recommended torque values" on page 9](#).
- Check that all quick release levers, including the quick release on the front wheel and the seatpost, are tight and properly secured. Ensure the front-wheel quick release lever is positioned so that the front fork lower doesn't prevent it from closing fully.
- Check that the fasteners on any accessories you've added are properly tightened according to the manufacturer's instructions.

Brake system

- Check brake pads and ensure the brake pad material isn't thinner than the backing plate it attaches to.
- Ensure brake pads are correctly positioned in relation to the brake rotors.
- Ensure brake cables are lubricated, correctly adjusted, and show no obvious wear.
- Ensure brake levers are properly positioned and tightly secured to the handlebar.
- Ensure the brake cable tension is appropriate.
- Check that the taillight brightens when you squeeze each brake lever.
- Use the techniques in ["Checking brakes & motor cutoff switches" on page 21](#) to test the brake levers, brakes, and motor cutoff switches.

Wheels & tyres

- Ensure tyres are holding air and inflated to within the recommended limits displayed on the tyre sidewalls.
- Ensure tyres have good tread, have no bulges or excessive wear, and are free from any other damage.
- Ensure rims run true and have no obvious wobbles, dents, or kinks. See ["Tyre and wheel care" on page 21](#).
- Check each wheel spoke. If any are loose or broken, seek help from a certified, reputable mechanic.
- Check the axle nuts on the rear wheel to ensure they are correctly tightened (see ["Tools and recommended torque values" on page 9](#)).
- Ensure the locking lever on the front-wheel quick release is positioned so that the front fork doesn't prevent it from closing fully.

Steering

- Ensure the handlebar and stem are correctly aligned, adjusted, and tightened for proper steering.
- Perform a handlebar twist test to ensure the stem clamp bolt is secure. See ["Handlebar twist test" on page 22](#).
- Ensure the handlebar is set correctly in relation to the fork and the direction of travel.
- Ensure the handlebar grips are secure and undamaged.

Bearings

- Check that headset, wheel, pedal, and bottom-bracket bearings are lubricated, run freely, and display no excess movement, grinding, or rattling.

Drivetrain: cranks, pedals, chain, chain tensioner

- Ensure pedals are securely tightened to the cranks. See [“Tools and recommended torque values” on page 9](#).
- Ensure the cranks are not bent and are securely tightened to the bottom bracket. See [“Tools and recommended torque values” on page 9](#).
- Ensure the chain is clean, oiled, and runs smoothly. Take extra care with chain maintenance if bike is used in wet, salty, dusty, or otherwise damaging conditions.
- Check that the chain tensioner is aligned and functioning properly.

Frame, fork, and seat

- Check that the frame and fork are not bent or broken.
- Check that the seat is adjusted properly, the seatpost quick release lever securely tightened, and the seat does not move when the lever is closed. Ensure that the seatpost minimum insertion marking is fully inserted into the frame.

Motor drive assembly & twist power assist

- Ensure the hub motor is spinning smoothly and is in good working order.
- Ensure the power cable running to the hub motor is secured and undamaged.
- Check the axle nuts to ensure they are correctly tightened (see [“Tools and recommended torque values” on page 9](#)).
- Ensure the torque washers, torque arm, and torque arm bolt are in place and secured.
- Ensure the twist power assist and pedal assistance are operating normally.

Battery

- Ensure the battery is charged.
- Ensure there is no damage to the battery.
- Lock the battery to frame and check that it is secured. Remove the key before riding.
- Ensure the battery gauge on the LED display and the charge status indicator on the battery read similarly.

Cables

- Look over electrical cable connectors to make sure they are fully seated and free from debris or moisture.
- Check cables and cable housing for obvious signs of damage.
- Ensure cables are secured away from moving parts.
- Ensure headlight, taillight, and brake light are functioning, adjusted properly, and unobstructed.

Accessories & safety gear

- Ensure all reflectors are properly fitted and not obscured.
- Ensure all accessories and components installed on the bike are properly secured and functioning according to their manufacturer's specifications.
- Check all safety gear, clothing, cargo, and accessories for loose or potentially loose straps/elements and secure them.
- Ensure rider is wearing a helmet and other required riding safety gear, and inspect these items for signs of damage.
- If your bike has fender/mudguards: Ensure they are centred over the wheels, adjusted properly, properly secured (see [“Tools and recommended torque values” on page 9](#)), and have no cracks or holes.



WARNING: Riding your bike when any component's useful life is surpassed can cause that component to fail, resulting in loss of control, serious injury, or death. Pay attention to signs of wear such as cracks, scratches, component colour change, and operational changes that could indicate a component needs replacing. Before each ride, check your bike using the [“Safety checklists” on the previous page](#). Perform regular maintenance according to [“Recommended service intervals” on the next page](#). If you're not sure you have the experience, skills, and tools to perform safety checks and regular maintenance, consult a local certified, reputable bike mechanic for help.

AFTER EVERY RIDE

- Store your bike and battery in a dry location and take other sensible precautions as described in [“Parking, storage, and transport” on page 16](#).

- Guard against damage from the elements by following the recommendations in [“Guard against rust, corrosion, and electrical damage” on page 23](#).
- Charge your battery in a temperature-controlled location between 10° C–25° C (50° F–77° F) and follow the other charging recommendations in [“Before you charge” on page 10](#).

Recommended service intervals

Regular maintenance of any bike is key to ensuring the best possible performance and reducing wear and tear on systems. Ideal service intervals vary depending on use conditions. We generally recommend inspections, service, and necessary replacements be performed at the time and distance intervals described below, but you should have your bike serviced more frequently if you ride aggressively, with heavy payloads, or in harsh conditions. Have your bike inspected immediately if you notice problems or your bike has been involved in a fall or other accident.

 **WARNING:** Have your bike inspected by a certified, reputable bike mechanic after any fall, crash, or accident, as these can cause damage (visible or internal/not readily apparent), make your bike unsafe, and lead to serious injury or death. Be particularly cautious about using a battery that has experienced a significant impact from a fall or crash; a damaged battery may not show external signs of damage. Using a damaged battery or charger can create additional bike damage or a fire hazard. For more information, see [“Battery information” on page 9](#).

AFTER BREAK-IN PERIOD OF 80–160 KM (50–100 MILES)

- Inspect**
- Check all cables and the chain for stretch.
 - Check spoke tension and the trueness of the wheels.
 - Check all bolted connections for loosening and ensure they are tightened to recommended torque values (see [“Tools and recommended torque values” on page 9](#)).
- Service**
- Have a certified, reputable bike mechanic perform a thorough tune-up.

 **WARNING:** Certain components can stretch or loosen during any bike’s break-in period, which can lead to component failure and potential injury or death. Be sure to have a certified, reputable bike mechanic perform a thorough tune-up after this break-in period or sooner if you notice any problems or ride aggressively, with heavy payloads, or in harsh conditions.

WEEKLY, 160–320 KM (100–200 MILES)

- Inspect**
- Check hardware for proper torque—see [“Tools and recommended torque values” on page 9](#).
 - Check drivetrain for proper alignment and function (including chain, freewheel, chainring, and chain tensioner).
 - Check wheel trueness and spoke tension, and check for quiet wheel operation (without spoke noise).
 - Check frame for any damage.
- Service**
- Clean frame by wiping frame down with damp cloth.
 - If needed, adjust the brake cable tension.
 - Clean and grease the chain.
- Replace**
- Replace any components confirmed to be broken or damaged beyond repair by Rad Power Bikes Product Support or a certified, reputable bike mechanic.

MONTHLY, 400–1200 KM (250–750 MILES)

- Inspect**
- Check brake pad alignment and brake cable tension.
 - Check chain stretch.
 - Check chain alignment and drivetrain functioning.
 - Check brake cables for corrosion and fraying.
 - Check wheel trueness and spoke tension, and check for quiet wheel operation (without spoke noise).

- Service**
 - Clean and lubricate drivetrain.
 - Check crankset and pedal torque.
 - Clean brake cables.
 - Tension spokes and true wheels if any loose spokes are found.
 - Optional: Balance the battery. This is not necessary if you've been charging your battery after nearly every use and haven't been storing it long term. See "[Balancing the battery](#)" on page 11 for more information.
- Replace**
 - Replace brake cables if necessary.
 - Replace brake pads if necessary (typically when the pad material is thinner than the backing plate).

EVERY 6 MONTHS, 1200–2000 KM (750–1250 MILES)

- Inspect**
 - Inspect drivetrain (chain, chainring, freewheel, and chain tensioner).
 - Inspect all cables and housings.
- Service**
 - Standard tune-up by certified, reputable bike mechanic.
 - Grease bottom bracket.
- Replace**
 - Replace brake pads.
 - Replace tyres if necessary.
 - Replace cables and housings if necessary.

Checking brakes & motor cutoff switches

All vehicles, including your RadMission, need reliable brakes. Test your brake levers, brakes, and motor cutoff switches for proper functioning before every ride. If anything seems wrong, take your bike to a local, certified, and reputable bike mechanic, refer to our Help Centre (www.radpowerbikes.eu/help), or contact Rad Power Bikes Product Support.

1. **Test the brake levers.**
 - a. Fully squeeze each lever, and ensure neither the front nor rear brake lever touch the handlebar grips.
 - b. Ensure both brake levers are properly lubricated. If they are, they'll be reasonably easy to squeeze without feeling as though there's grit in the mechanism, and when you release them, they will immediately go back to their original position.
 - c. Make sure each lever is properly oriented and firmly secured to the handlebar.
2. **Test each brake.**
 - a. Squeeze the left brake lever to lock the front brake, and then try to push the bike forwards using the handlebar. The front wheel should not spin.
 - b. Squeeze the right brake lever to lock the rear brake. Again, push against the handlebar to try moving the bike forwards. The rear wheel should not spin.
3. **Test the motor cutoff switches.** The front and rear brake levers contain motor cutoff switches, which cut off power from the motor whenever the brakes are applied.
 - a. In a clear, open area, turn on the bike. With appropriate safety gear and clothing, sit on the bike.
 - b. Squeeze the left brake lever to engage the front brake.
 - c. Lightly apply the twist power assist. The bike should not move since the brake is applied.
 - d. Release the twist power assist.
 - e. Release the brake.
 - f. Test that the twist power assist now operates with the brake not engaged.
 - g. Release the twist power assist.
 - h. Perform steps "a"–"g" again, this time with the rear brake lever (on the right side of the handlebar).

Tyre and wheel care

The RadMission uses 27.5" x 1.95" rubber tyres with inner tubes. The tyres are designed for durability and safety for regular cycling activities. Wheels and tyres need to be checked before each use for proper condition. Always replace tyres and inner

tubes with punctures, cuts, bulges, damage, or excessive wear before you ride.

TYRE INFLATION

Inflate tubes and tyres to within the pressure range printed on the tyre sidewall. For additional information about tyre pressure, please consult our online Help Centre at www.radpowerbikes.eu/help.



WARNING: Underinflating your tyres can result in loss of control. Overinflating can make tyres burst. Either scenario can lead to serious injury or death. Always maintain the correct air pressure of your tyres, which is listed on the tyre's sidewall, and use a regulated air source with pressure gauge so that you can measure pressure accurately.

WHEEL "TRUENESS"

Your wheels should always spin straight ("true") and must be repaired or replaced if they wobble side to side or up and down when spinning. To test them, do this:

1. Spin the wheel.
2. Brace a dull pencil against the frame or fork, with the tip just touching the rim.

If the gap between spinning rim and pencil changes more than 5 mm, your wheels may need truing. If your wheels become untrue or if spokes loosen, which can happen with normal use, we recommend that you have a certified, reputable bike mechanic perform wheel tuning and truing operations. Do not attempt to true wheels or tighten spokes unless you have the highly specialized skills and tools to do so.

TYRE REPLACEMENT

Even tyres equipped with built-in flat-preventative tyre liners, like those that come with your RadMission, can and do get flats from punctures, pinches, impacts, and other causes. If you get a flat tyre or can see evidence of tyre wear, you must replace your tyres and/or tubes before operating the bike again. Otherwise, you risk bike/property damage, serious injury, or death.



CAUTION: Removing a tube from your wheel rim before the air has been released from it can cause the tube to burst, potentially causing serious injury. Always release air pressure before removing your tube.



WARNING: Aftermarket tyres or inner tubes not provided by Rad Power Bikes may not be compatible with your wheels or the performance requirements of your ebike. Such tyres can fail or create unsafe riding conditions, causing serious injury or death. Always use replacement tyres and tubes that are sized to be compatible with your bike frame. For safety, and if required by law, ensure replacement tyres have sufficient reflective sidewall striping.

For more information on tyre or tube replacement or about tyre inflation, visit www.radpowerbikes.eu/help or contact Rad Power Bikes Product Support at eu-support@radpowerbikes.com or +31-85 7470430.

Handlebar twist test



WARNING: An improperly secured wheel and/or handlebar stem can cause loss of control, accidents, serious injury, or death. Check that the front wheel and handlebar stem are properly secured during assembly and before each ride.

1. **Brace the front wheel.** Stand at the front of the bike, facing the handlebar, and brace the front wheel between your feet and lower legs.
2. **Try to twist the handlebar.** Hold both handlebar grips and push forward with one hand while pulling back with the other. Push and pull at the same time with about 20 lb of force with each hand.
3. **Ensure the handlebar and wheel stay properly aligned.** The handlebar and handlebar stem should be tightly secured perpendicular to the front wheel.
4. **Repeat the twist test pulling/pushing with the opposite hands,** using about 20 lb of force pushing with one hand and 20 lb of force pulling with the other hand.
5. **If needed, align the handlebar and stem and torque the stem clamp bolts evenly.** Instructions for doing so are in ["Assembly instructions for the RadMission" on page 2](#). Be sure to torque the stem clamp bolts evenly to the specification listed in ["Tools and recommended torque values" on page 9](#). After torquing the stem clamp bolts to the proper specification, perform the twist test again. If the handlebar still moves, contact Product Support.

WARNING: If you are not sure you have the experience, skills, and tools to correctly perform all steps to secure and verify the security of the handlebar, front wheel, and handlebar stem you **MUST** consult a certified, reputable bike mechanic to check your work and/or secure those components to the bike properly

Guard against rust, corrosion, and electrical damage

WARNING: DAMAGE TO YOUR EBIKE'S ELECTRICAL SYSTEM CAUSED IN ANY MANNER, INCLUDING WATER INTRUSION, CAN LEAD TO BATTERY FAILURE, ELECTRICAL SYSTEM MALFUNCTION, OR ELECTRICAL FIRE AND CONSEQUENT PROPERTY DAMAGE, INJURY, OR DEATH. Follow all recommendations below to minimize chance of water damage. If you have any questions, contact Rad Power Bikes Product Support.

Like any vehicle used outdoors, your RadMission needs care to ensure it isn't damaged by the elements. Follow these steps for a long, healthy life for your ebike:

- Store under shelter and in an upright position for best drainage; avoid leaving the bike in the rain or exposed to corrosive substances. If exposed to rain, dry your bike afterwards, and apply anti-rust treatment to the chain and other unpainted steel surfaces.
- To clean your bike, wipe the frame with a damp cloth. If needed, apply a mild, non-corrosive detergent mixture to the damp cloth and wipe the frame. Dry by wiping with a clean, dry cloth. Never use the spray from a hose or a high-pressure washer on your bike.
- Avoid riding on the beach or in coastal areas. Doing so exposes your bike to salt, which is very corrosive. Wipe down your bike frequently and wipe or spray all unpainted mechanical parts with anti-rust treatment. Damage from corrosion is not covered under warranty.
- If painted metal parts become scratched or chipped, use touch-up paint or nail polish to prevent corrosion.
- Never immerse or submerge the bike or any components in water or liquid, which can damage the electrical system.
- Exposure to salt water can cause permanent, irreversible damage to electronic components.

Troubleshooting

Problem	Most common solutions
Bike doesn't work:	
Insufficient battery power	Charge the battery
Faulty connections	Clean and repair connectors
Battery not fully seated in tray	Install battery correctly
Improper turn-on sequence	Turn on bike with proper sequence
Brakes are applied	Disengage brakes
Discharge fuse issue	Replace 40A discharge fuse
Irregular acceleration and/or reduced top speed:	
Insufficient battery power	Charge or replace battery
Loose or damaged twist power assist	Replace twist power assist
When powered on, the motor does not respond:	
Loose wiring	Reconnect or repair
Loose or damaged twist power assist	Tighten or replace
Loose or damaged motor plug wire	Reconnect or replace
Damaged motor	Repair or replace

Reduced range:

Low tyre pressure	Inflate tyres to recommended PSI
Low battery	Charge battery
Driving with too many hills, headwind, braking, or excessive load	Assist with pedals or adjust route
Battery discharged for long period without regular charges	Balance the battery (see “Balancing the battery” on page 11); contact Rad Power Bikes Product Support if range decline persists
Brakes rubbing	Adjust the brakes
Faulty, damaged, or aged battery	Contact Rad Power Bikes Product Support to replace battery. Disconnect and store damaged battery in a safe location and recycle or dispose of as soon as possible according to local rules.

The battery won't charge:

Charger not well connected	Adjust the connections
Charger damaged	Replace
Battery damaged	Disconnect and store battery in a safe location and recycle or dispose of as soon as possible according to local rules. Contact Rad Power Bikes Product Support to replace battery.
Wiring damaged	Repair or replace
Charge fuse issue	Replace the 5A charge fuse







Wheel or motor makes strange noises:

Loose motor cable connection	Reconnect cable
Damaged wheel spokes or rim	Repair or replace
Damaged motor wiring	Repair or replace motor

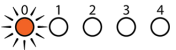
Error detection

Your RadMission is equipped with an error detection system integrated into the display and controller (see [“Electrical controls & operation” on page 13](#) for more information). In the rare event of an electrical issue with the bike, you may see a specific combination of lights flash on the Pedal Assistance Level lights on the display. If this happens at any time, we recommend that you cease operation, take a short video of the light(s) flashing if possible, and then go to the Rad Power Bikes online Help Centre (www.radpowerbikes.eu/help) for more information.

The following errors are the most common and can aid in troubleshooting.

PAS lights flashing	Error type
0	 Abnormal current
1	 Twist power assist fault
0 and 1	 Motor phase fault
2	 Motor hall fault
0 and 2	 Brake switch fault (or the brake was applied while turning bike on)
All lights	 Communication fault

Ride as safely as possible

Ride Rad by taking the sensible measures outlined in this section to maximize your safety. Bicycling is an exciting, delightful, and practical way to get around, but like any sport, it involves risk of injury and death. By choosing to ride a bike, you assume responsibility for those risks.

 **WARNING:** Incorrect assembly, maintenance, or use of your RadMission can cause component or performance failure, loss of control, serious injury, or death. Even if you're an experienced bike rider, **you must read and understand the entire manual and any documentation provided for subcomponents or accessories before riding.** If you are not sure you have the experience, skills, and tools to correctly perform all assembly steps in the manual and the assembly video at www.radpowerbikes.eu/help, consult a local, certified, reputable bike mechanic.

Be thoroughly educated about your bike before riding it

Practise riding your bike, braking, and using the twist power assist and pedal assist systems in a controlled location before venturing into traffic or other risky conditions.

The electrical system on your ebike (see [“Electrical controls & operation” on page 13](#)) offers various levels of power assistance and lighting for different operating conditions and user preferences. Be sure you understand these features before riding. The twist power assist should provide smooth acceleration when gradually applied. If the twist power assist, pedal assistance, or lighting is functioning abnormally, intermittently, or not at all, please discontinue using your ebike immediately and contact Rad Power Bikes Product Support for assistance.

Take extreme care getting to know and learning to control the pedal assist and brake systems. Your RadMission is probably heavier than other bikes you've ridden, and it will handle quite differently from lighter bikes, especially when you're accelerating or decelerating. Learn to maintain a comfortable stopping distance from all other objects, riders, and vehicles at different speeds, conditions, and with varying payloads.

 **WARNING:** Using the front brake by itself can cause excessive stress on components, damage to the bike and parts, loss of control, injury, or death. Always apply the rear brake before applying the front brake, using both brakes for all operations.

Age and ability requirements

The RadMission is designed for persons at least 16 years of age, and a parent or legal guardian should always decide whether a child should operate the RadMission or any other vehicle. Some localities may require ebike riders to be older than 16.

Riders must also have the physical ability, reaction time, and mental capability to understand and obey all local laws governing ebike usage and to manage traffic, variable road conditions, and sudden situations. If you have an impairment or disability (e.g., visual impairment, hearing impairment, physical impairment, cognitive or language impairment, seizure disorder) or any other limitation that could affect your ability to safely operate a vehicle, consult your physician before riding any bike.

 **DANGER:** Riding any bike under the influence of alcohol, drugs, or any substance or condition that could impair your motor function, judgment, reaction time, or ability to safely operate a vehicle puts you at VERY HIGH RISK of serious injury or death. Operate bikes and other vehicles only when you're sober and otherwise physically and mentally prepared to ride safely.

Know and obey all relevant local laws

The RadMission 1 is a 250 watt (W) pedelec. Please check relevant legislation in the locations you intend to ride for a full understanding of all necessary legal requirements for operating your RadMission 1. This manual will refer to your RadMission 1 as the “RadMission 1,” “RadMission,” “bike,” “ebike,” or “electric bike.” It is your responsibility to know the local laws that govern any type of vehicle you use.

Safety check before each ride

Before each ride, you must check your bike to ensure everything is working properly. Follow the instructions on the [“Safety checklists” on page 18](#) and ground your safety checks in a solid understanding of bike maintenance, which is explained in [“Maintenance” on page 17](#), a section that includes an important chart, [“Recommended service intervals” on page 20](#), which you should follow as well.

If you are ever unsure how to check or maintain your bike or if you find any problems with it, take it to a certified, reputable bike mechanic or contact Rad Power Bikes Product Support.

Ride appropriately for conditions

Always travel at speeds appropriate for local terrain and conditions as well as your experience level. **When in doubt, slow down.** Always use a low pedal assist level until you are comfortable with your RadMission and confident about controlling its power, weight, and responsiveness (e.g., during start-up, turns, and braking) at different speeds, in different conditions, and with whatever payloads you might carry.

Riding with your headlight on will make you more visible in any conditions. The headlight will turn on when the bike is powered on. We recommend you keep it on whenever you ride.

Concentrate on the path ahead. Avoid potholes, gravel, ice, wet or oily roads, wet leaves, curbs, train tracks, speed bumps, drain gates, thorns, broken glass, and other obstacles, hazards, and puncture flat risks.



WARNING: Crossing train tracks or similar grooved or raised surfaces at a diagonal can make the surface “grab” or deflect your wheel, causing your bike to suddenly get stuck or crash, leading to serious injury or death. Always cross such hazards at a perpendicular angle or, when in doubt, dismount and walk your bike across.

PATH RIDING

Be a good citizen of shared-use paths and facilities. Keep your speed reasonable and below path speed limits, pass carefully and kindly. Use your voice and/or bell to signal your presence to others, especially when passing.

ROAD RIDING

When riding on streets, obey the same road laws as all other road vehicles as well as local rules governing bike or ebike usage. Sharing the road with other vehicles presents many hazards. Always take these precautions:

- Expect the unexpected such as opening car doors or cars backing out of driveways.
- Be extra careful at intersections and when preparing to pass other vehicles or other cyclists.
- Ride predictably, in a straight line, and with the flow of traffic. **Never ride against traffic.**
- Use correct hand signals to indicate turning, and do so well in advance of turning.
- Ride defensively. To other road users you may be hard to see.
- Increase your visibility by following the tips in [“Low-visibility conditions” on the next page](#).

OFF-ROAD RIDING

Riding off road requires close attention and specific skills, and it presents variable conditions and hazards. Don't ride off road unless you have the appropriate skills. If you choose to ride off road, wear appropriate safety gear and do not ride alone in remote areas.

HOT OR COLD CONDITIONS

Riding, parking, or storing your bike in excessively hot conditions can cause damage to the display and other components. Do not park or store your bike in direct sunlight for extended periods. Excessive heat can damage the bike's electronics or the battery, and can cause intermittent power outages, as the battery is designed to shut off automatically to prevent operation at unsafe temperatures. If you ride in hot conditions, using lower PAS levels and less twist power assist can help reduce temperature rise in electrical components.

Riding in very cold conditions can cause battery range to decline (the colder the environment, the greater the range decline). We recommend that you not operate your bike in temperatures less than -4° F (-15° C).

LOW-VISIBILITY CONDITIONS

 **WARNING:** Riding at night or in other low-visibility conditions (dawn, dusk, fog, rain, mist, snow, etc.) makes it harder to see and avoid hazards and makes it harder for others to see and avoid you, which increases risk of accidents, serious injury, or death. Wet, slippery surfaces will compound your risk of injury or death. Avoid these conditions whenever possible. If you must ride in these conditions, following the guidelines below can reduce risk.

- Wear reflective and brightly coloured clothing.
- Slow down.
- Use familiar routes with street lighting if possible.
- Ensure tyre wall, pedal, and other reflectors are installed and unobstructed.
- Ensure headlight and taillight/brake light are functioning correctly and unobstructed. Use them.

WET CONDITIONS

This electric bike is not meant for use in puddles, heavy rain, or streams. Never immerse or submerge this product in water or liquid as the electrical system may be damaged.

 **WARNING:** Riding in wet conditions means slippery hands, feet, and riding surfaces, which greatly increases your risk of accidents, serious injury, or death. Low-visibility conditions (night, dusk, dawn, fog, mist, rain, snow, etc.) will compound your risk of injury or death. If you must ride in wet conditions, following the guidelines below can mitigate risk somewhat.

- Decrease riding speed to help you control the bike in slippery conditions.
- Brake earlier since it will take longer to slow down than in dry conditions.
- Take care to be more visible to others on the road, following the tips in [“Low-visibility conditions” above](#).
- Remember that road hazards are more difficult to see when wet, so proceed with extra caution.

EXTREME RIDING

There are no appropriate conditions for extreme riding. Although many articles, advertisements, and catalogues depict extreme riding, Rad Power Bikes strongly recommends against such inappropriate and dangerous use of its products.

 **DANGER:** Extreme riding puts you at **VERY HIGH RISK** of serious injury or death. Extreme riding includes but is not limited to jumps, stunts, or any riding that exceeds your capabilities or the strength and integrity limitations of certain bike components and/or otherwise leads to dangerous situations. Never engage in extreme riding or any type of riding that exceeds your capabilities.

Wear a helmet and appropriate safety gear

We strongly advise that you wear a properly fitting, certified bicycle safety helmet while riding your bike, which may be required by law in your area.

Wear appropriate safety gear including closed-toe shoes. If you are wearing loose pants, secure the bottom using appropriate leg clips or bands to prevent the fabric from flapping and getting caught in the chain or other moving parts. Never use items such as headphones or hoods that can compromise your hearing or field of vision. A local, certified, and reputable bike shop can help advise you on what gear is best for the weather and other riding conditions in your area.

Maximize your visibility with bright colours and reflective outerwear or vests. Never compromise your ability to be seen or heard by removing your bike’s reflectors, blocking or removing the headlight or taillight, or removing the bell.

 **DANGER:** Riding any bike without a helmet puts you at **VERY HIGH RISK** of serious head injury or death. Always wear a properly fitted helmet that covers the forehead. Many locations require specific safety devices. It is your responsibility to familiarize yourself and comply with the laws, rules, and regulations where you ride.

Limited warranty and other terms

Your bike's warranty and other binding legal terms (e.g., terms of purchase, etc.) are subject to change at any time. To view your terms of purchase, go to www.radpowerbikes.eu/terms. To view the current warranty, please go to www.radpowerbikes.eu/warranty.